

2019



CHV5

MULTI-ZONE VRF AIR CONDITIONING SYSTEMS ALL DC INVERTER



MULTIZONE DC INVERTER SYSTEMS CHV5

DC Inverter Multi VRF System with its high-efficient inverter compressors has four exciting features which are different from those found on traditional inverter air conditioners: excellent energy-saving effect, more reliable and precise operation, smarter network control, providing users with best air conditioning experience.



C O N T E N T S

04	_____	CHV5
24	_____	CHV5 mini and slim
32	_____	CHV5 heat recovery
43	_____	Indoor units
82	_____	Energy recovery ventilation (ERV)

CHV5



Key features

All DC inverter technology to improve compression efficiency

All DC inverter compressor and high-performance high pressure chamber are adopted to reduce loss of overheat and improve compression efficiency from direct intake. Compared with low pressure chamber, the compression efficiency is improved. High-efficient permasyon motor is adopted to provide better performance than traditional DC inverter compressor.

All DC inverter compressor

- All DC inverter compressor is used in this system. It can directly intake gas to reduce loss of overheat and improve efficiency.

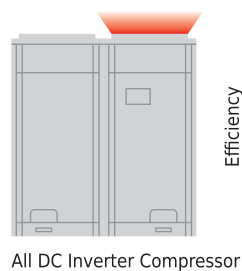

Efficiency

HP chamber structure can raise the high and middle frequency performance

New DC motor (concentrated winding) raises the low frequency performance

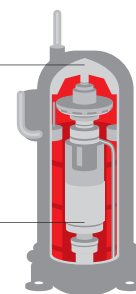

- High-efficient permasyn motor is adopted to provide better performance than traditional DC inverter compressor.

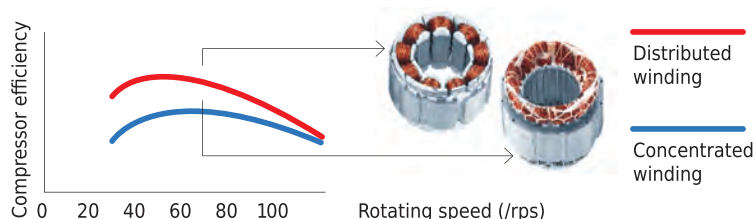

- **Technology of maximum torque control with minimum current.**

It can reduce energy loss caused by device winding so as to realize higher efficiency.

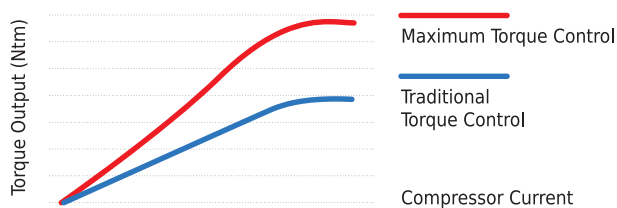

- **180° Sine Wave DC Speed Varying Technology**

It can satisfy various places' demands for different temperature and is able to save a great deal of electricity and provide users with utmost comfort at the same time.

- **Low-frequency torque control.**

It can directly control motor torque, through which fan motor can run at a low speed. Users will feel more comfortable while requirements of the system are also met..

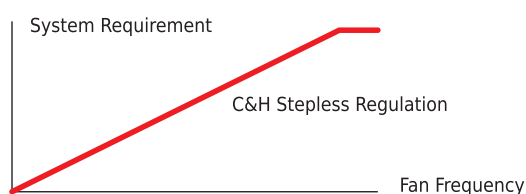

Traditional Control

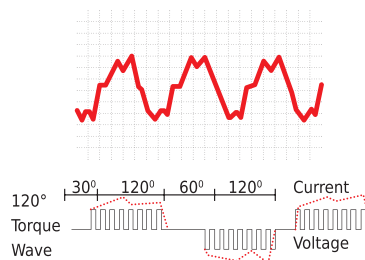

180° Sine Wave D.C. Control

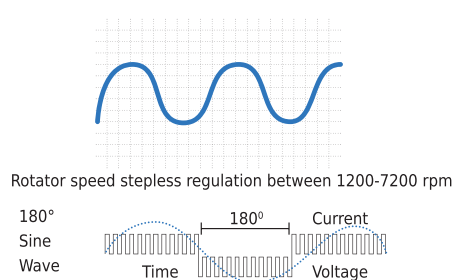

Sensorless DC inverter fan motor

- Stepless speed regulation ranges from 5Hz to 65Hz. Compared with traditional inverter motors, the operation is more energy-saving.

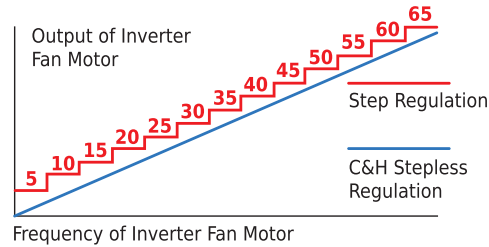

- Sensorless control technology guarantees lower noise, less vibration and steadier operation.

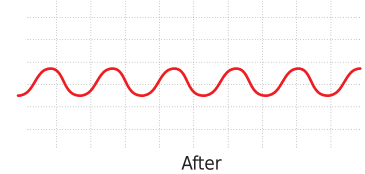
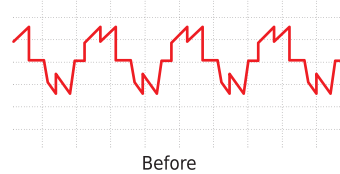

Max capacity 249 kW — the largest free combination

Max capacity of single outdoor unit reaches 61,5 kW and max combination capacity is even up to 246 kW, in an industry leading level.

Max combination capacity is extended to 246 kW



Money is saved in system cost and piping

Before

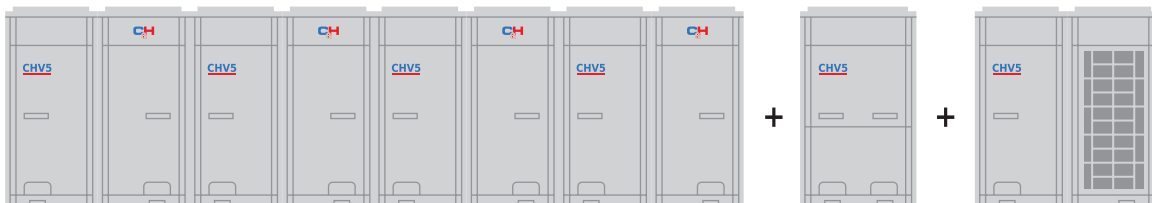

Now

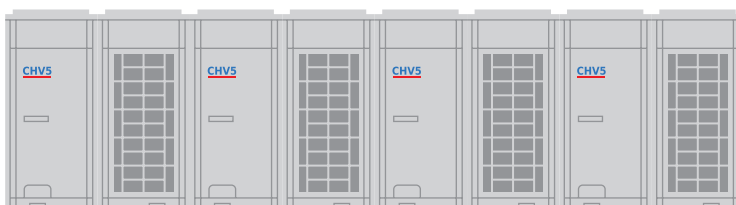

Compact design

With compact design, the outdoor unit can be carried to the roof of building through elevator, with no need of crane. It is easier for delivery and installation.

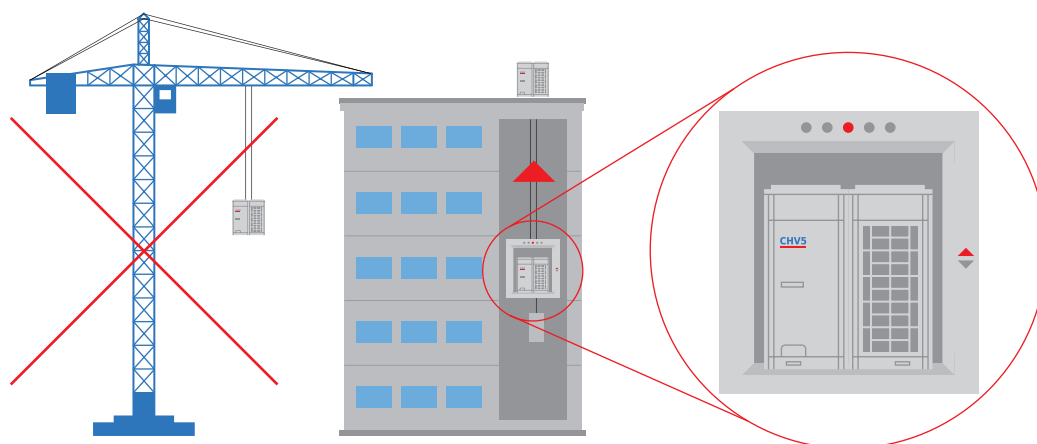

Non-polar CAN technology to improve communication efficiency

- C&H is the first one to adopt non-polar CAN communication technology in the industry. CAN communication technology provides quicker system response speed, more convenient installation debugging and more reliable communication data.

Performance Index	Company A Multi-VRF Network	CHV5 DC Inverter CAN Network
Reliability	Software check	Hardware check, more reliable
	One unit's communication error may lead to a breakdown of the whole network	If one unit has errors, it will exit from the network without any influence to other units.
Communication Efficiency	Low utilization	High utilization
	Communication speed is about 10Kbps.	Communication speed is 20Kbps.
Compatibility	One main network, difficult to add new equipment	Multiple main networks, easy to add new equipment.
Communication Distance	1000 m	1500 m

- The non-polar CAN communication technology is applied to support flexible wiring installation, greatly reducing construction difficulties

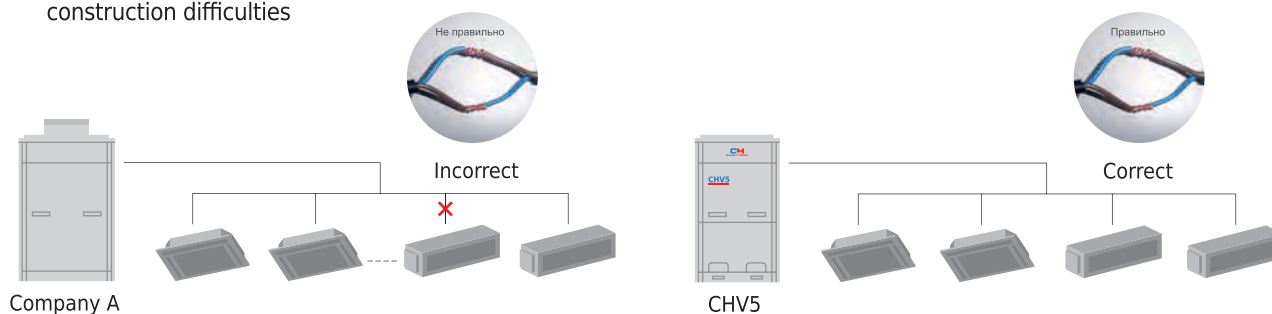

Wide range of operation condition

- CHV5 working range of system voltage rates has become more: 320-460 V. It much wider than traditional voltage standard, which is 342-420 V. That system will operate normally even in mode of unstable voltage rates.



- Outdoor operation temperature range is improved to $-5^{\circ}\text{C} \sim 52^{\circ}\text{C}$ in cooling and $-20^{\circ}\text{C} \sim 24^{\circ}\text{C}$ in heating.

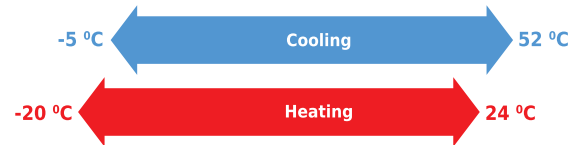

Wider applicable location

- CHV5 can realize a combination of 4 outdoor unit modules connecting with as many as 80 indoor units. It's especially applicable for business building or hotels.

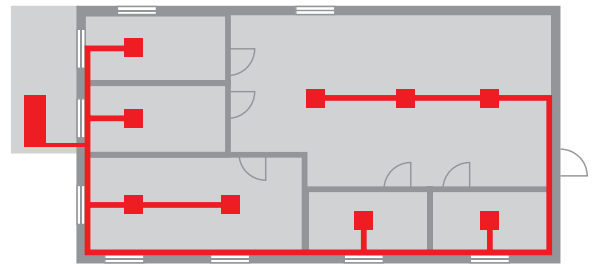

Refrigerant storage and distribution

- The CHV5 system is designed without liquid receiver and the excess refrigerant is stored in the piping, which can minimize the refrigerant charging volume and enhance the control accuracy of refrigerant.

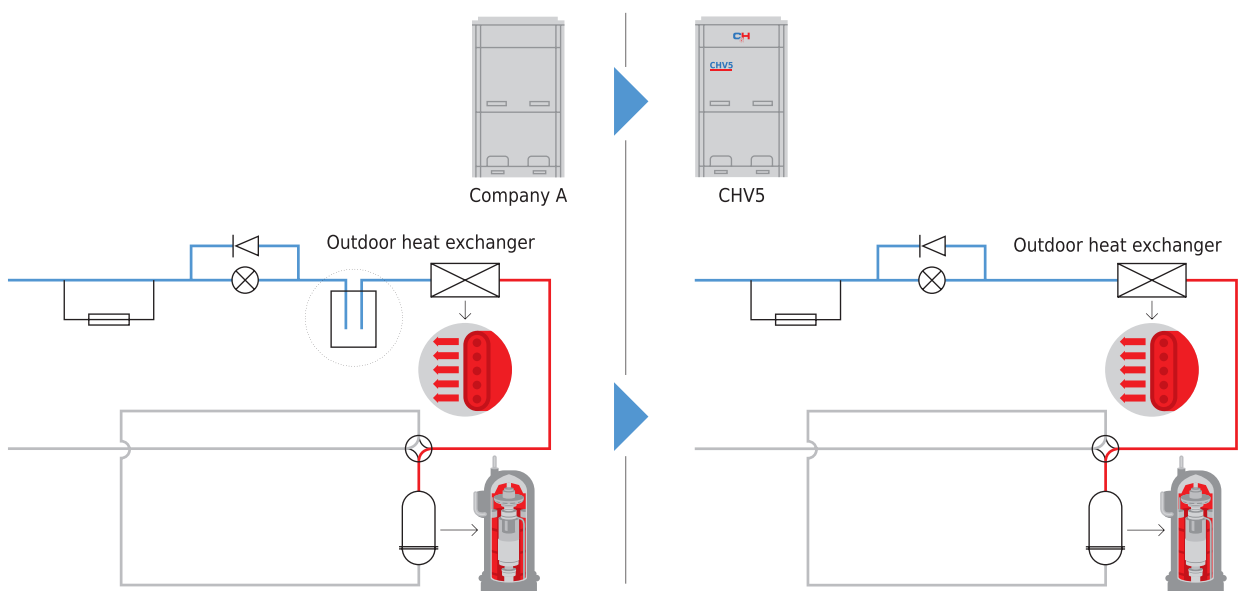



High efficiency and more energy saving

After 10 years of research and development of CHV5 system, we still continue our excellence to higher quality level and now in 5th generation models we receive, much more energy efficiency and saving of heating and cooling.

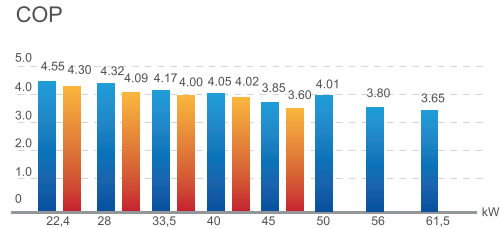
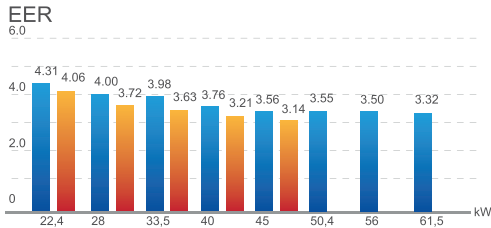

New generation of energy-saving operation control technology with energy saving up to 20%

The CHV5 system has 2 modes for energy saving, which can be chosen to meet different electricity demands.

Mode 1:

In auto energy-saving mode, the system will self-adjust parameters according to the operation status, thus to lower the cost of electricity. Up to 15% of energy can be saved.

Mode 2:

In compulsory energy-saving mode, the system will

limit power output forcibly. Up to 20% of energy can be saved.

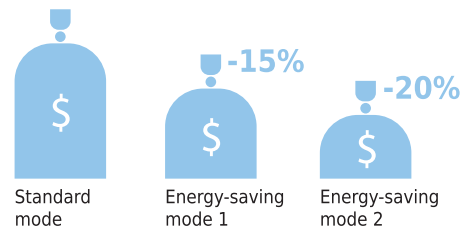

Intelligent defrosting control

During the heating process, the frost status of the unit will be different after affecting by factors of outdoor ambient temperature, load status and operation time. Through real-time detection of operation parameters of the system, it can decide the defrosting time by intelligently estimating the thickness of frost, high pressure of system and blockage status of heat exchanger.

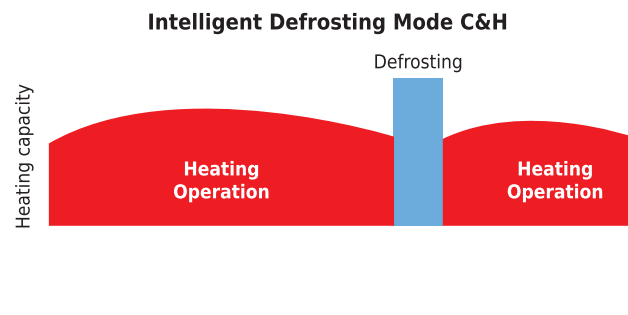
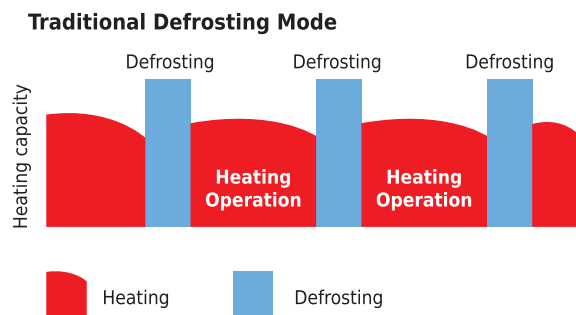

Heating (Red) Defrosting (Blue)

Accurate intelligent allocation technology of capacity and output of optimal portion to ensure highest efficiency

- When total load demands more than 75% of a running system's capacity, one more unit will automatically start;
- When total load demands less than 40% of a running system's capacity, one unit will automatically shut down;
- Therefore, each unit shares 40%-75% of the total load.
- Experiments show that an air conditioner costs the least energy when it's operating within 40%-75% of its capacity.

	Company A	CH CHV
Allocation Method	28,3 kW (full load) + 5,66 kW (full load)	17 kW (partial load) + 17 kW (partial load)
Performance Compared	Unit costs more energy and may be soon damaged.	Unit costs less energy and can always be kept in good condition.

➤ Output of optimal portion to ensure highest efficiency

The best heating or cooling performance can be realized in the most energy-saving way. DC inverter compressor and DC inverter fan will also be operating in this way to ensure high efficiency.

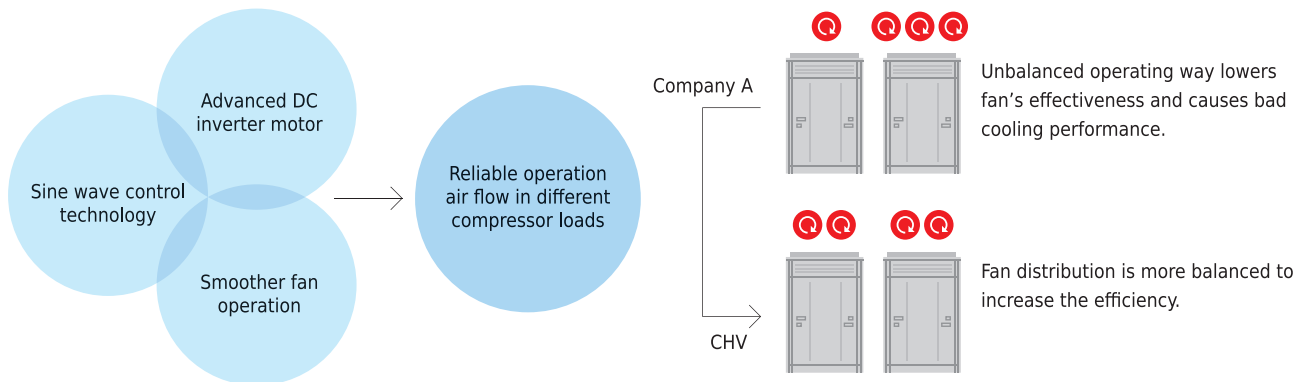

Sub-cooling Control Technology to Ensure Optimal Cooling and Heating

- Heat exchange loop can control the first subcooling process of heat exchanger. Subcooling degree can reach 11°C.

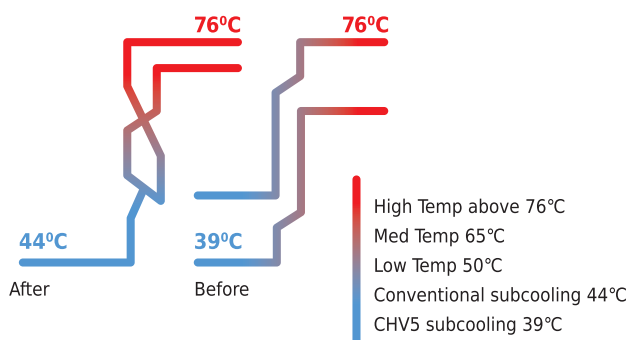

- Subcooling loop can realize 9 °C second subcooling to guarantee cooling and heating performance.

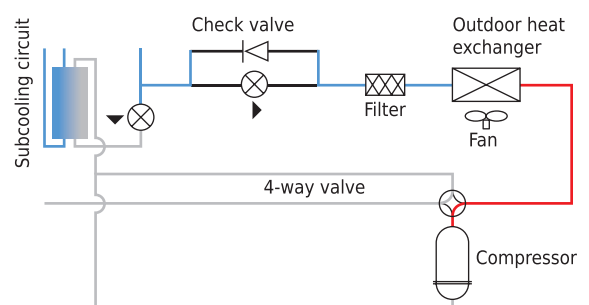

Temperature controlled by wired controller with higher efficiency and more energy saving

Through setting temperature lower limit in cooling or dry mode, and setting temperature upper limit in heating, 3D heating or heat supply mode, the system is able to operate in a smaller temperature range so as to achieve energy saving.



Comfortable design for a better life

The CHV5 system has a wide range of working conditions. Whether it's in a cool winter or a hot summer, normal operation is guaranteed with the least noise, making users feel more comfortable.

Outdoor unit quiet mode and quiet control

Quiet at night

The system can record the highest outdoor temperature. At night, the system will automatically turn to quiet mode. There are 9 quiet modes which can be set according to actual needs.

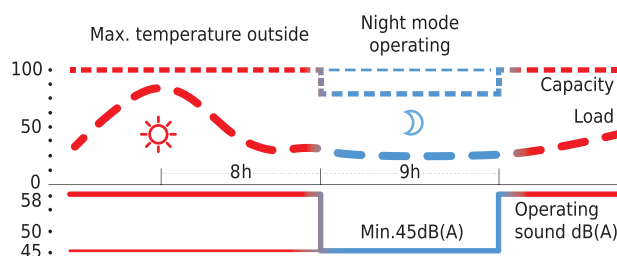

Quiet in compulsion

The system can also be set in this mode to ensure low noise as long as it is operating. Noise is as low as 45dB(A).

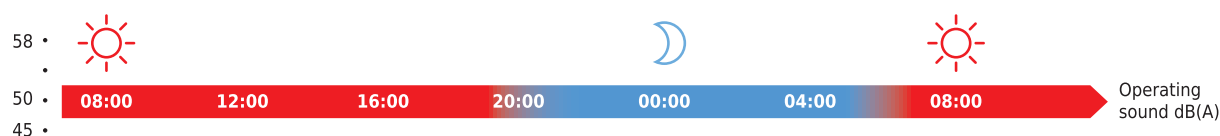

Quiet control

1. Optimized Bossing Design

After many times of CFD tests, a new fan bossing structure has been developed to reduce vibration of fan during running. Noise can be reduced by 3dB(A).

2. Aerodynamics 3D Axial Fan.

Compared with conventional fan, it can increase air volume by 12%, improving efficiency as well as lowering noise.

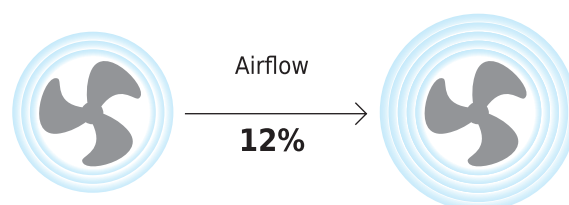

Quiet indoor unit

The indoor unit of the CHV5 system also adopts DC inverter motors to realize stepless regulation. According to indoor temperature or people's needs, users can set this mode through wired controller. Noise is as low as 22dB(A).

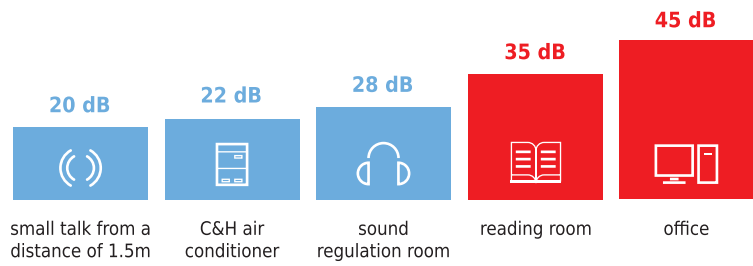

Fast start-up in heating

DC Compressor is first started to avoid too much electric current. Inverter compressor can operate in high frequency once starts up, so as to produce more heat.

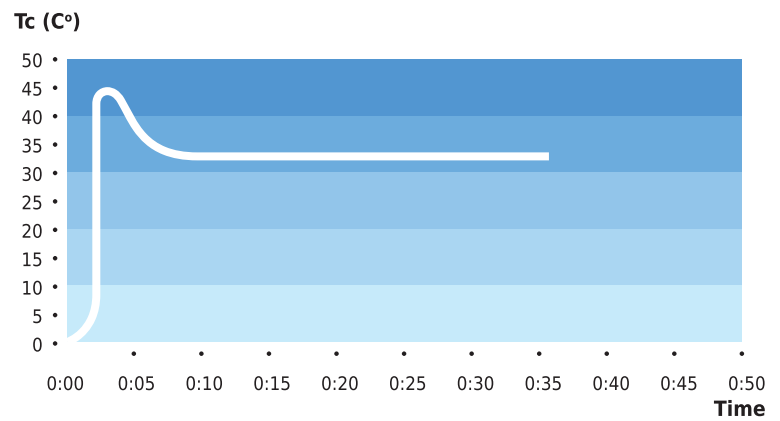

7 Speeds indoor fan

Indoor fan speed can be set in 7 levels by wired controller. They are auto, low speed, medium-low speed, medium speed, medium-high speed, high speed and turbo.

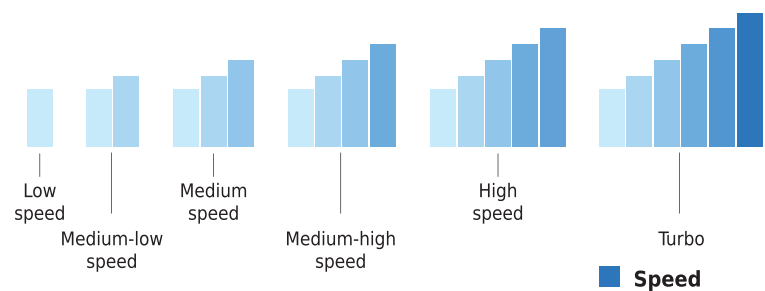



Excellent performance ensured by advanced technology

After 10 years of research and development of CHV5 system, we still continue our excellence to higher quality level and now in 5th generation models we receive, much more energy efficiency and saving of heating and cooling.

Two-stage oil separation control technology (patented)

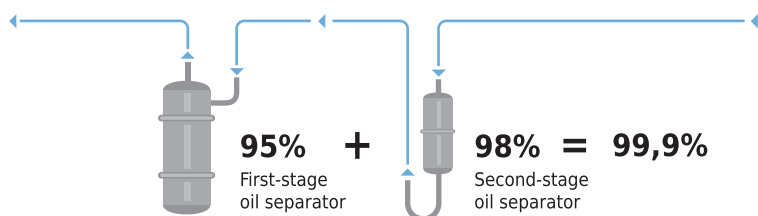

First-stage oil separator adopts a filtration expansion valve with separation efficiency of 98%; Second-stage oil separator will separate the remained 2% refrigerant oil with separation efficiency of 95%. General oil separation efficiency reaches 99.9%.

Oil return control technology

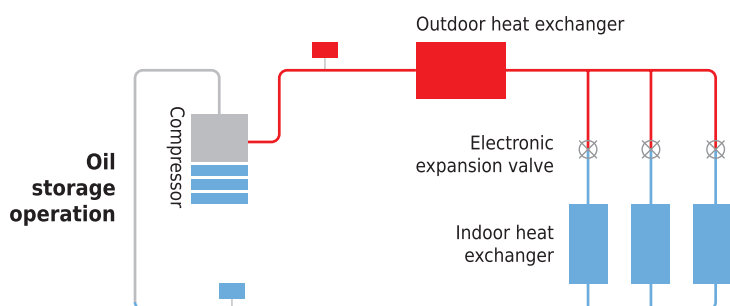
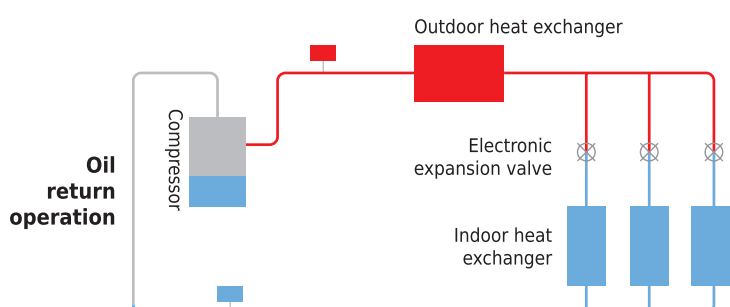
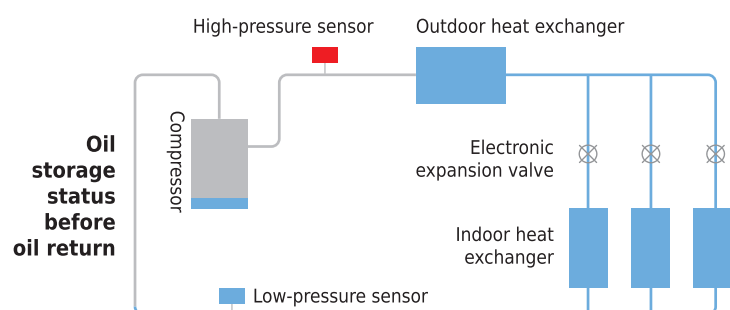

New oil return control

C&H new oil return control technology effectively controls system oil return and oil storage status of each compressor, which greatly improves the operation lifespan of compressor.

Specialized compressor oil storage control

The system applies specialized compressor oil storage technology, which can control the lowest oil level for compressor operation.

Oil balance control technology

Oil balance between each module

Based on the actual status of each module and compressor, the system can regulate compressor's operation and realize oil balance of each module.

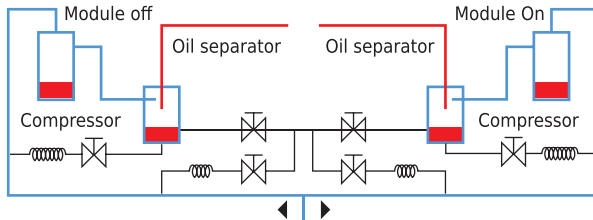

Oil balance between each compressor

Refrigerant is taken into the compressor by the suction pipe and then runs through the cooling system. It can control the oil level and minimum oil volume required by each compressor so as to realize oil balance between each compressor.

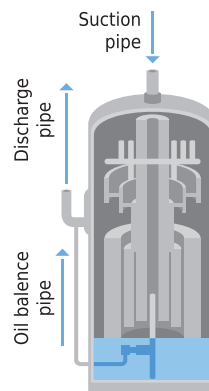

Intelligent detection control

Pressure sensor detection control

Pressure sensor can precisely detect system high pressure and low pressure, and adjust output of fan and compressor, so as to make sure the system can work under the most energy-saving pressure condition

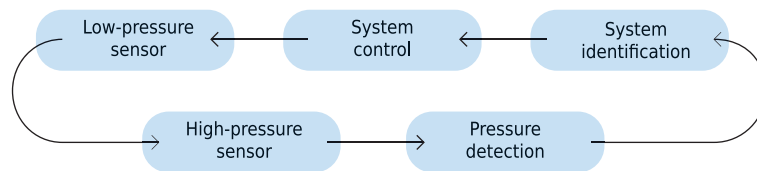

Temperature sensor detection control

Various temperature sensors are equipped to detect ambient temperature, indoor temperature and refrigerant's evaporating temperature, from which the operation status can be measured.

Multi electronic expansion valves control

Outdoor electronic expansion valve not only has throttling effect, but also control refrigerant flow. The system adopts multi electronic expansion valves control with total 960 grades regulated by two electronic expansion valves, so as to regulate refrigerant flow precisely and ensures reliable operation of system.

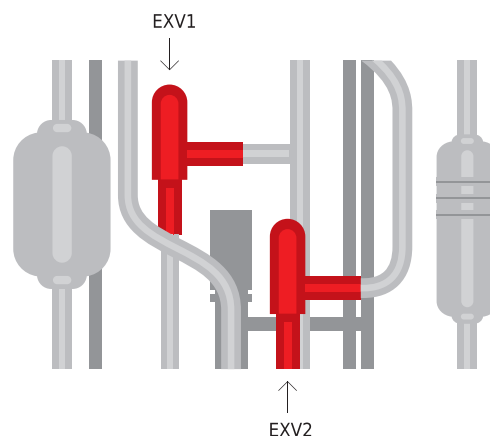

Smaller impact to power grid

The start-up frequency of inverter compressor is gradually increased from 0Hz to the appointed operation frequency. The start-up current of compressor rotor is decreased by reducing load torque, hence impact to power grid during start-up is reduced and electromagnetic impact to compressor is reduced too.

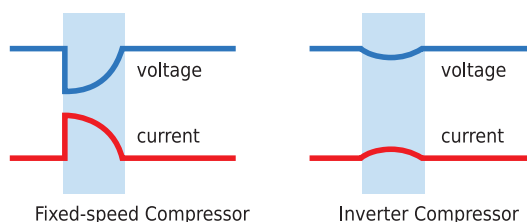

Modules rotation operating to maximize lifespan

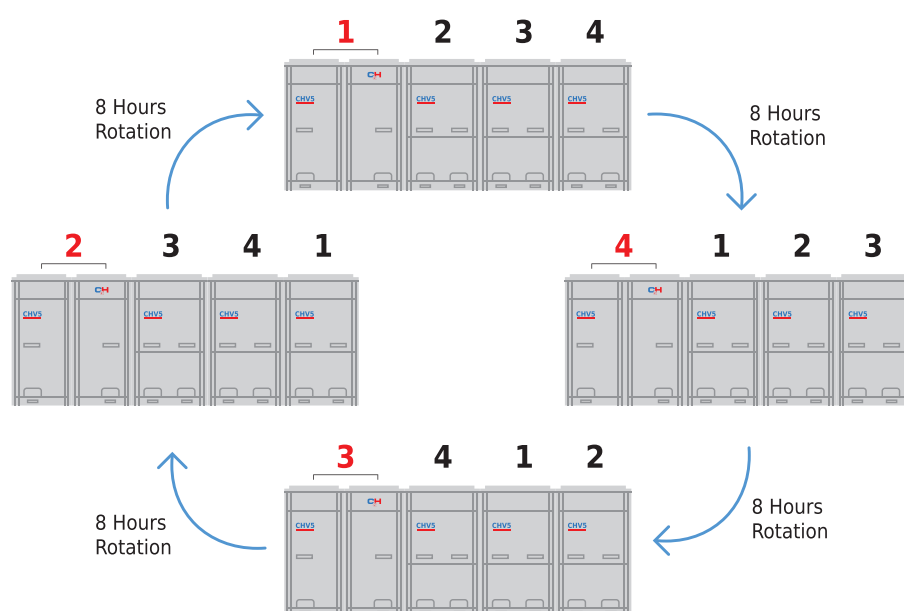

Modules 8h rotation operating

The operating priority sequence of the outdoor unit modules will be changed without restart when the system accumulatively operates for 8 hours, which can maximize the service life of the system.

Highly anticorrosive Golden Fins

The primary material of Golden Fin is Al-Mn(Aluminum-Manganese) anti-rust alloy, which is coated with the Golden Protection Layer(Components: Epoxy Resin & Modified Acrylic, Silicon free), the anti-corrosive performance in salt-spray testing is 200%~300% higher than normal Blue Fin*.

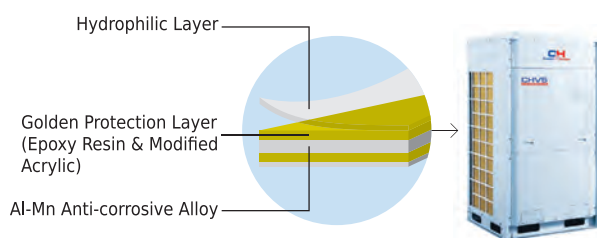

Note: Salt-spray testing result is from C&H materials chemistry testing laboratory.

Emergency auto-off control

The outdoor unit can be linked with a fire alarm signal. In case of emergency, unit can automatically turn off to avoid risk or further loss.



Electricity shortage identification

The outdoor unit can receive a power signal of electricity shortage. In some places like first-class hotels, if diesel generator is used temporarily for providing electricity, outdoor unit will send the electricity shortage signal to indoor unit. In this case, only VIP rooms can be provided with air conditioning service.

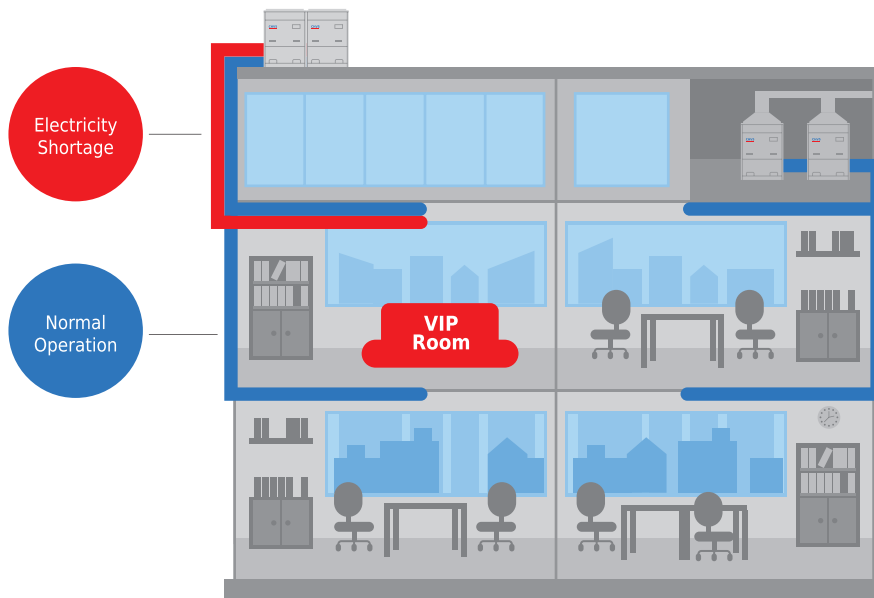

Excellent emergency operation function to ensure reliable operation

➤ Emergency function

The CHV 5 system can realize a combination of 4 outdoor unit modules. When error is occurred to one of the modules, the others will perform the emergency operation to sustain the air conditioning.



➤ Emergency operation of compressor

All the compressors in each single module are DC Inverter based, when one compressor has error, others will perform the emergency operation.

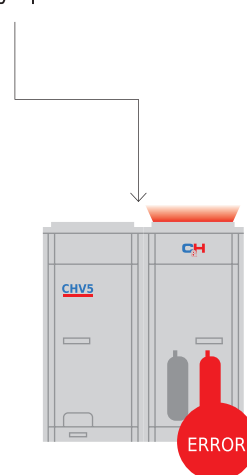

➤ Emergency operation of fan

Double-fan design fan ensures that one fan can still work even if the other one has error.

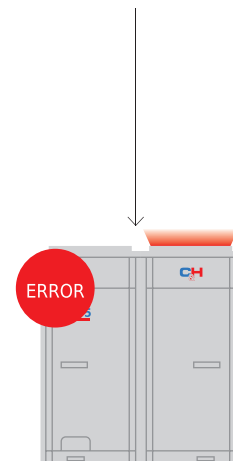



Easy installation to various types of designs

ODU high static pressure design

System has 4 levels of static pressure that can be set. Up to 82Pa pressure can be set for an outdoor unit. This design is especially useful when an outdoor unit needs to be placed indoor.

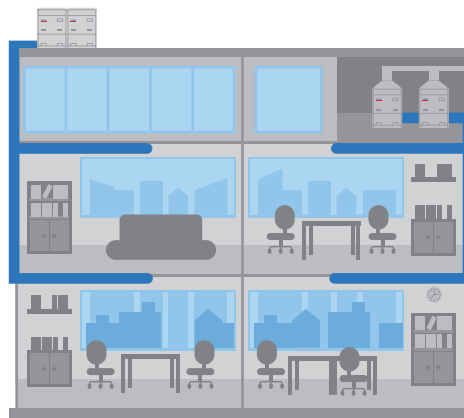

1000m pipe design for flexible installation

CHV 5 system can be applied in different types of building construction. One of its advantages is the simple pipe design, which will simplify the installation and reduce installation cost.

- Max total pipe length reaches 1000m (with limitation);
- Actual pipe length between the outdoor unit and the farthest indoor unit: 165m;
- Max height difference between indoor unit and outdoor unit: 90m.

Note:

a: Distance between the first branch and the farthest indoor unit.

b: Distance between the first branch and the nearest indoor unit.

$a-b \leq 40m$

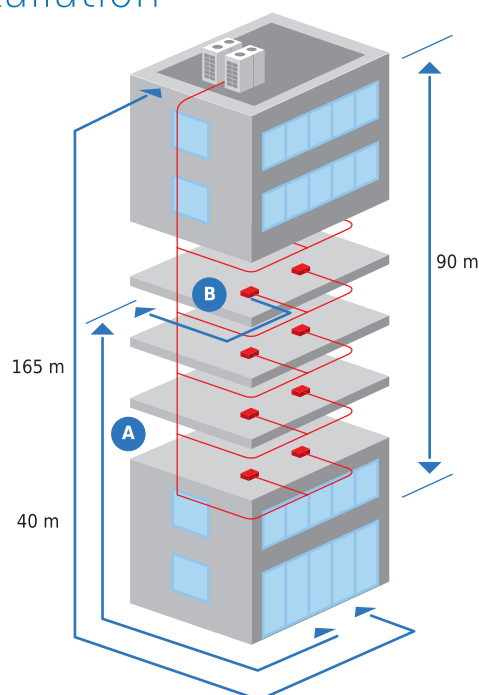

Engineering debugging for convenient construction

CHV5 has five auto debugging features:

1. Automatic allocation of IDU and ODU addresses
2. Automatic detection of IDU and ODU quantity
3. Automatic detection of errors
4. Automatic start-up of debugging
5. Real-time judgment of pipe errors

Auto-refrigerant recovery for easy maintenance

When auto refrigerant recovery function is set and cut-off valve of liquid pipe is closed during maintenance, the system will automatically operate compressor, EXV, solenoid valve and fan, etc. Taking advantage of compressor power, the refrigerant is recovered at the condensing side of outdoor unit to achieve environmental effect. Meanwhile, system low pressure is displayed simultaneously during refrigerant recovery.

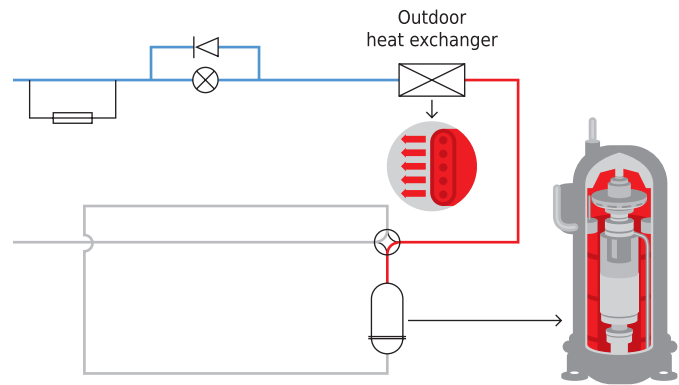

Inspection window for convenient checking

Inspection window is available for quick checking of system operation status. No need to open panel for checking, which will be more time-saving and easier for maintenance.

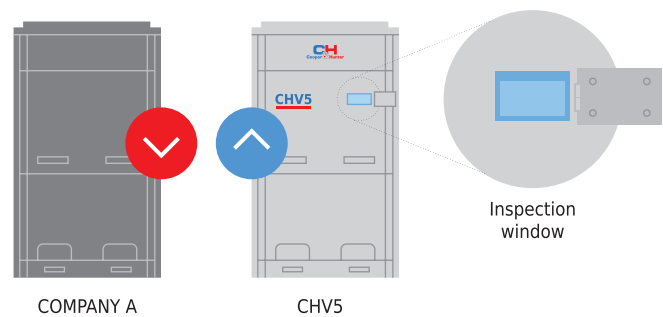

Flexible wiring

Common wire can meet the communication demand with no need of specialized communication wire. Common sheath twisted pair cable can be used as there is no polarity requirement.

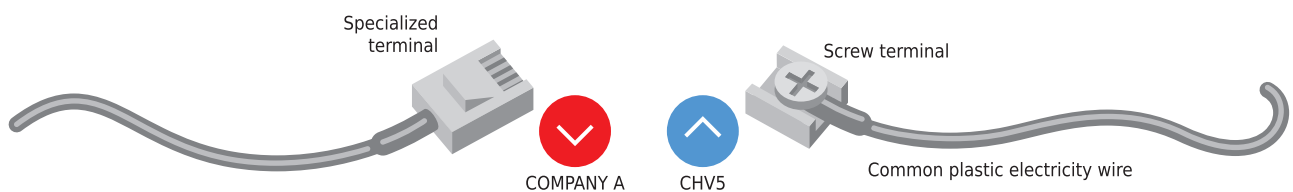

Auto addressing of outdoor and indoor unit

CAN network is adopted to achieve auto addressing of outdoor and indoor unit. It can allocate IDU and ODU addresses and detect IDU and ODU quantity, which greatly improves construction efficiency.



Professional hotel functions

C&H CHV5 provides hotels with unique season setting function and key-card control function.

Season setting

Cooling or heating mode can be deactivated during a certain season to avoid affecting unit's normal operation due to mode conflict.



Heating mode is deactivated in summer



Cooling mode is deactivated in winter

Key-card control for hotel management

The unit can be turned on or off by inserting or removing the key-card. When the key-card is removed, the system can remember all the setting and stop operation. When the key-card is inserted back, the system will be under standby mode or operate according to the status before removing key-card. It is well suited to hotels, restaurants, etc.





SPECIFICATIONS & PARAMETERS OF OUTDOOR UNITS

Outdoor units lineup

Model	CHV-5S224NMX2	CHV-5S280NMX2	CHV-5S335NMX2	CHV-5S400NMX2	CHV-5S450NMX2	CHV-5S504NMX2	CHV-5S560NMX2	CHV-5S615NMX2
CHV-5S224NMX2	•							
CHV-5S280NMX2		•						
CHV-5S335NMX2			•					
CHV-5S400NMX2				•				
CHV-5S450NMX2					•			
CHV-5S504NMX2						•		
CHV-5S560NMX2							•	
CHV-5S615NMX2								•
CHV-5S680NMX2		•		•				
CHV-5S730NMX2		•			•			
CHV-5S785NMX2		•				•		
CHV-5S850NMX2		•					•	
CHV-5S900NMX2		•						•
CHV-5S960NMX2			•					•
CHV-5S1010NMX2				•				•
CHV-5S1065NMX2					•			•
CHV-5S1130NMX2						•		•
CHV-5S1180NMX2							•	•
CHV-5S1235NMX2								••
CHV-5S1300NMX2		•			•		•	
CHV-5S1350NMX2		•			•			
CHV-5S1410NMX2			•		•			•
CHV-5S1460NMX2		•					•	•
CHV-5S1515NMX2		•						••
CHV-5S1580NMX2			•					••
CHV-5S1630NMX2				•				••
CHV-5S1685NMX2					•			••
CHV-5S1750NMX2						•		••
CHV-5S1800NMX2							•	••
CHV-5S1845NMX2								•••
CHV-5S1908NMX2		•			•		•	•
CHV-5S1962NMX2		•				•	•	•
CHV-5S2016NMX2		•					••	•
CHV-5S2072NMX2		•					•	••
CHV-5S2128NMX2		•						•••
CHV-5S2184NMX2			•					•••

Model	CHV-5S224NMX2	CHV-5S280NMX2	CHV-S335NMX2	CHV-S400NMX2	CHV-S450NMX2	CHV-5S504NMX2	CHV-5S560NMX2	CHV-5S615NMX2
CHV-5S2240NMX2			
CHV-5S2295NMX2				
CHV-5S2350NMX2					
CHV-5S2405NMX2						
CHV-5S2460NMX2							

Specifications of outdoor units

380-415V, 50/60Hz

Модель		CHV-5S224NMX2	CHV-5S280NMX2	CHV-5S335NMX2	CHV-5S400NMX2	CHV-5S450NMX2	CHV-5S504NMX*2	CHV-5S560NMX*2	CHV-5S615NMX*2	
Capacity range	HP	8	10	12	14	16	18	20	22	
Capacity	Cooling	kW	22,4	28	33,5	40	45	50,4	61,5	
	Heating	kW	25	31,5	37,5	45	50	56	63	
EER	W/W	4,73	4,48	3,98	3,80	4,6	3,35	2,97	2,40	
COP	W/W	5,20	5,56	5,25	4,73	3,85	4,20	4,60	4,50	
Power supply	V/Ph/Hz	380-415V-3Ph-50/60Hz								
Max. circuit / Fuse current	A	16,1/20	20,9/25	24,7/32	28,8/40	33,2/40	36,8/40	43,8/50	48,9/50	
Power consumption	Cooling	kW	5,2	7	8,41	10,65	12,65	14,9	18,9	22,3
	Heating	kW	5,5	7,3	9	11,1	13	14,6	17,5	21,8
Maximum drive IDU NO.	unit	13	16	19	23	26	29	33	36	
Refrigerant charge volume	kg	5,9	6,7	8,2	9,8	10,3	12,7	13	13,5	
Sound pressure level	dB(A)	60	61	63	63	63	65	66	66	
Connecting pipe	Liquid	mm	Φ9,52		Φ12,7			Φ15,9		
	Gas	mm	Φ19,05	Φ22,2	Φ25,4		Φ28,6			
	Oil balance	mm						Φ9,52		
Dimension (W*D*H)	Outline	mm	930*765*1605		1340*765*1605			1340*765*1740		
	Package	mm	1010*840*1775		1420*840*1775			1420*840*1910		
Net weight/Gross weigh	kg	225/235	225/235	285/300	360/375	360/375	400/415	400/415	400/415	
Loading quantity	40' GP	set	24	24	16	16	16	16	16	
	40' HQ	set	24	24	16	16	16	16	16	



CHV5 mini & slim



Key Features

All DC Inverter Technology to Improve Compression Efficiency

All DC inverter compressor and high-performance high pressure chamber are adopted to reduce loss of overheat and improve compression efficiency from direct intake. Compared with low pressure chamber, the compression efficiency is improved. High-efficient permasyon motor is adopted to provide better performance than traditional DC inverter compressor.

All DC Inverter Compressor

- All DC inverter compressor is used in this system. It can directly intake gas to reduce loss of overheat and improve efficiency.

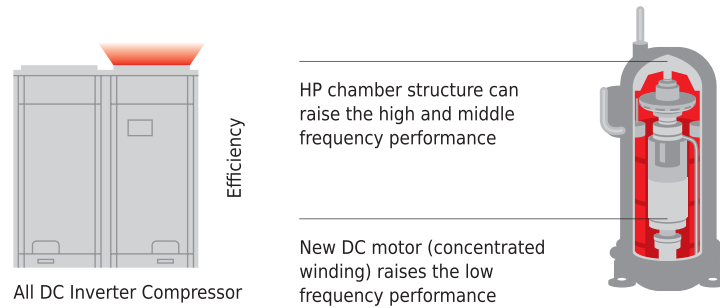

- High-efficient permasyn motor is adopted to provide better performance than traditional DC inverter compressor.

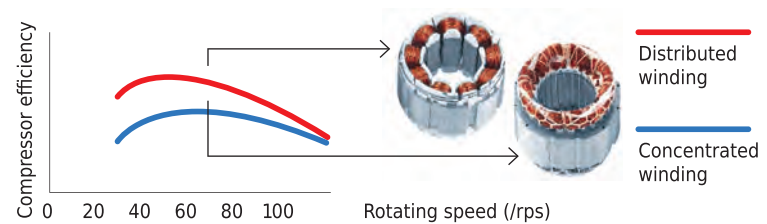

- **Technology of maximum torque control with minimum current.**

It can reduce energy loss caused by device winding so as to realize higher efficiency.

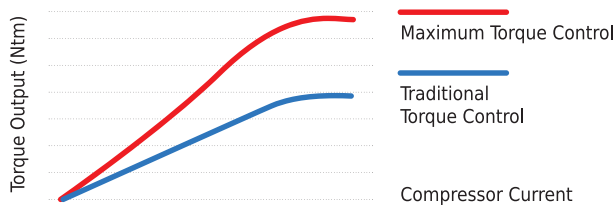

- **180° Sine Wave DC Speed Varying Technology**
It can satisfy various places' demands for different temperature and is able to save a great deal of electricity and provide users with utmost comfort at the same time.

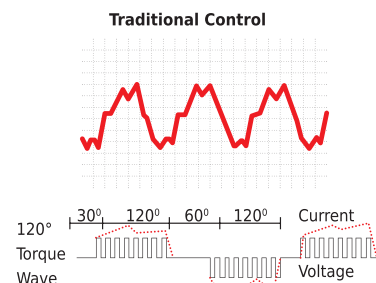

- **Low-frequency Torque Control.**

It can directly control motor torque, through which fan motor can run at a low speed. Users will feel more comfortable while requirements of the system are also met.

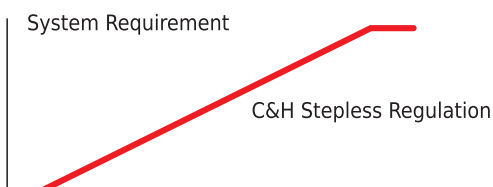

180° Sine Wave D.C. Control

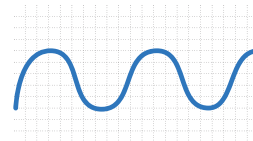

Rotator speed stepless regulation between 1200-7200 rpm

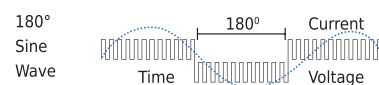

Sensorless DC inverter fan motor

- Stepless speed regulation ranges from 5Hz to 44Hz. Compared with traditional inverter motors, the operation is more energy-saving.

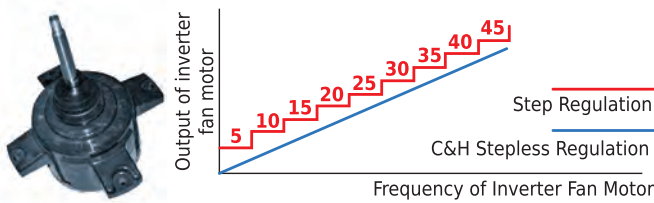

- Sensorless control technology guarantees lower noise, less vibration and steadier operation.

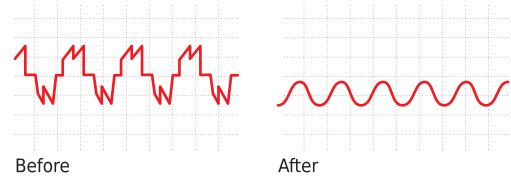

Sensorless DC inverter fan motor

The indoor unit adopts high-efficiency brushless DC motor. Compared with conventional motor, the efficiency of brushless DC motor is improved by more than 30%. Meanwhile, the design of evaporation capacity flow is optimized through emulation software of refrigeration system and the heat exchange amount of evaporator is greatly improved.

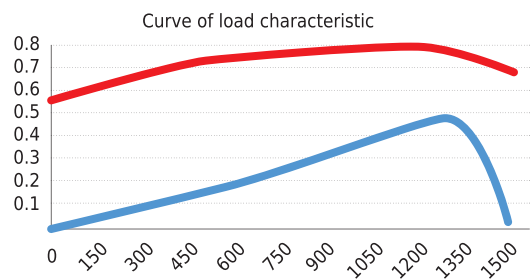

High-efficiency digital PFC control*

High-efficiency PFC control technology is adopted with efficiency improved by about 1% compared with conventional PFC. For the air conditioner with rated power of 5kW, 50W of electricity can be saved every hour and 1.2kW of electricity can be saved every day.

*This feature is applicable for CHV 5 Mini only.

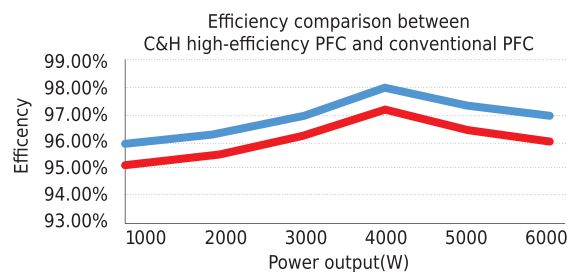

Wider operation condition range

The unit adopts DC motor with more accurate high pressure control, which effectively solves the high pressure control problem in low ambient temperature cooling. So the operation range in cooling is wider.

Company A	C&H CHV5 Mini	C&H CHV5 Slim
Cooling:10~48°C Heating:-20~27°C	Cooling:-5~52°C Heating:-20~27°C	Cooling:-5~52°C Heating:-20~27°C



Comfortable and quiet mode

Low noise of outdoor unit

- The advanced sub-cooling control technology is applied to reduce the liquid flow noise of indoor unit in cooling operation.
- Noise of outdoor unit can be as low as 45dB(A) thanks to noise optimized design of fan system and compressor system, and multiple kinds of quiet modes of outdoor unit.

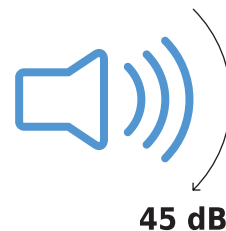

Low noise of indoor unit

- The pioneering and patented high-efficiency centrifugal fan blade and low-noise volute are adopted. Meanwhile, the imported silent valve is adopted to reduce noise of entire unit as low as 22dB(A).
- By adopting the optimal inlet angle of centrifugal fan blade and optimal diameter ratio between internal and external circles of impeller, the air volume is increased and fan noise is decreased greatly.
- The advanced supercooling control technology and the oil-return technology under heating mode has efficiently solved the problem of liquid flow noise of indoor unit, which improved the sound quality of indoor unit.



Intelligent temperature control technology

Intelligent temperature control technology is adopted for super fast cooling or heating, so that indoor temperature will reach set temperature more quickly.

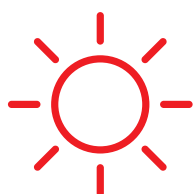

Fast cooling



Fast heating

Intelligent defrosting control

During the heating process, the frost status of the unit will be different after affecting by factors of outdoor ambient temperature, load status and operation time. Through real-time detection of operation parameters of the system, it can decide the defrosting time by intelligently estimating the thickness of frost, high pressure of system and blockage status of heat exchanger.

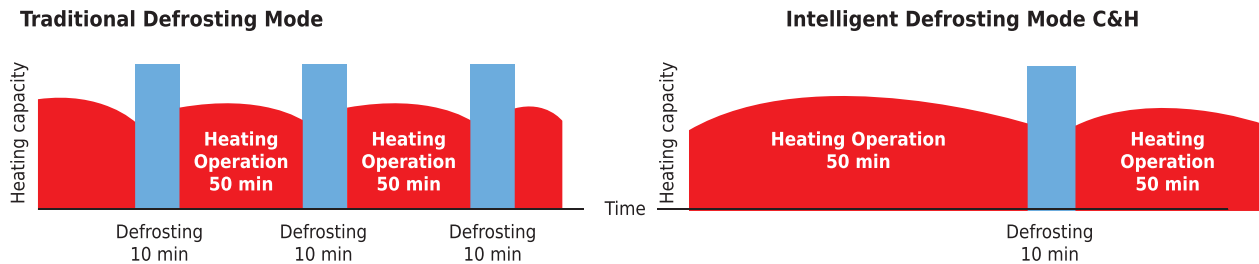

Note: This feature is fit for heat pump models only.

Non-commutative oil return technology in heating

The unit can achieve non-commutative oil return in heating when outdoor ambient temperature is within 0~20°C. Thanks to this technology, indoor ambient temperature is more stable and comfort is improved in heating mode.

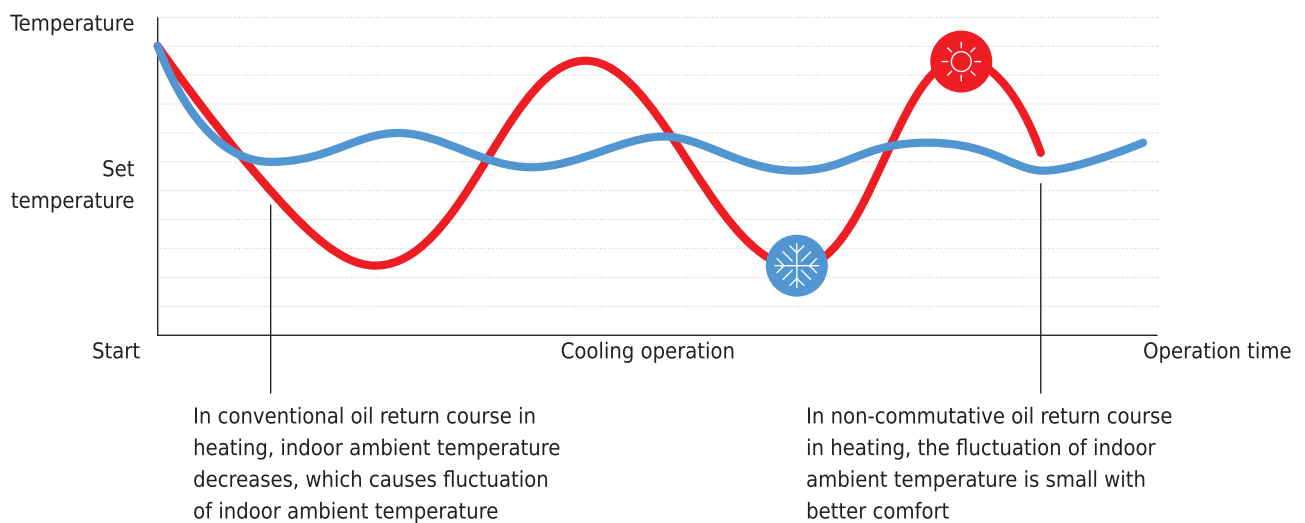



Reliable operation

Compressor closed-loop startup technology with more reliable startup

The self-innovative closed-loop startup control technology is adopted. Thanks to this technology, the startup current is small and startup is more reliable.

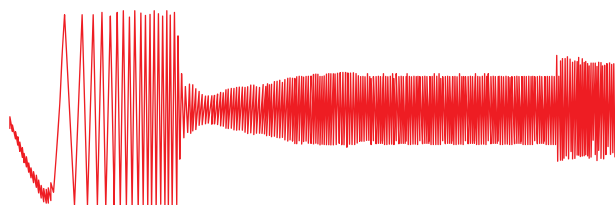

Conventional startup mode

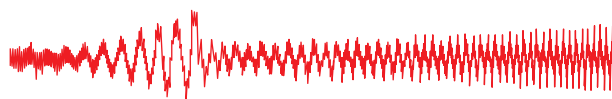

C&H closed-loop startup mode

High anti-interference ability



The latest CAN bus communication technology is adopted, with non-polar communication and high anti-interference ability. Common communication wire can meet the communication demand with no need of specialized shielded wire. The customers can buy the communication wire by themselves, greatly reducing installation difficulties.

Advanced high-frequency transformer with more stable voltage

Linear transformer

Linear power supply
(Linear inverter
+
Voltage-regulation chip)

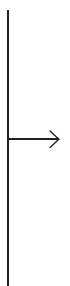

High-frequency transformer

Switching power supply
(High-frequency inverter
+
Switching chip)

- The advanced switching power supply is adopted with lower power consumption and higher power efficiency.
- Wide voltage-regulation range ensures stable voltage output when the voltage of grid fluctuates.
- Compared with conventional transformer, the size of high-frequency transformer is small and the weight is light.

Refrigerant cooling technology

Usually, air-cooled fins are adopted for heat radiation. Due to large size and passive radiation, heat radiating effect is unsatisfactory; with refrigerant cooling technology, heat radiating effect is much better because of compact structure and active radiation. Module temperature is dropped from 80°C to 65 °C, which will increase module life and stability.

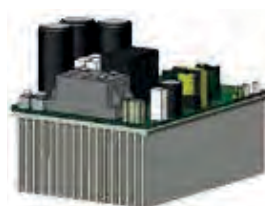

Common heat radiation

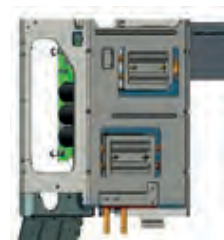

Refrigerant cooling

Ultra-long connection pipe for more convenient connection

Under the subcooling control technology gained by adding subcooler, the indoor unit and outdoor unit of CHV5 mini can operate reliably with longer connection pipe.

	Company A	CHV5 Slim C&H	CHV5 Mini C&H
Total piping length	150 m	300 m	300 m
Equivalent piping length	70 m	150 m	150 m

Top advanced light and compact size

CHV5 slim adopts small and compact size design. The dimension of the unit is 1430(H)×940(W) ×320(D). Compared with the normal product with the same capacity, size and weight are reduced a lot.

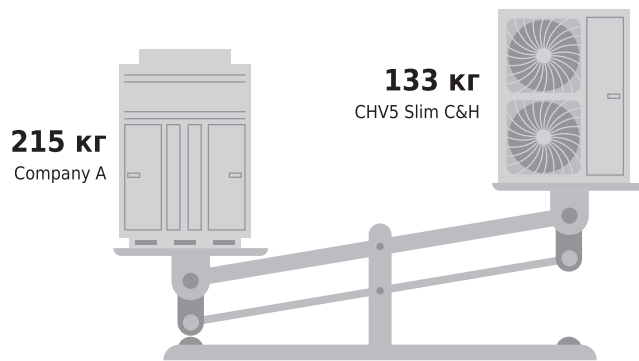

Easy installation with lower construction cost

The outdoor unit of CHV5 slim is with small size and light weight. No need fork lifter and crane for movement and installation



Movement by stairs and elevator

The outdoor unit of CHV5 slim is with compact and small size for saving space and easy movement. It can be carried by elevator or stairs.



CHV5 Mini & Slim Lineup

Mini Lineup

kW	Model	Product
11,3	CHV-5S120NK2	
14,6	CHV-5S140NK2	
17	CHV-5S160NK2	

Slim Lineup

kW	Model	Product
22,4	CHV-5S224SNMX2	
28	CHV-5S280SNMX2	
33,5	CHV-5S335SNMX2	

Mini 50/60 Hz

Model			CHV-5S120NK2	CHV-5S140NK2	CHV-5S160NK2
Capacity range		HP	4	5	6
Capacity	Cooling	kW	12,1	14	16
	Heating	kW	14	16,5	18,5
EER		kW / kW	3,97	3,52	3,3
COP		kW / kW	4,28	4,14	3,96
Power supply		V/Ph/Hz	220~240V 1Ph-50 Hz & 208~230V-1Ph-60 Hz		
Max. circuit / Fuse current		A	28,1/32	31,8/32	33,6/40
Power consumption	Cooling	kW	3,05	3,98	4,85
	Heating	kW	3,27	3,99	4,67
Maximum drive IDU NO.		unit	7	8	9
Refrigerant Charge volume		kg	5	5	5
Sound pressure level		dB(A)	55	56	58
Connecting pipe	Liquid	mm	Φ9,52		
	Gas	mm	Φ15,87		Φ19,05
Dimension(WxDxH)	Outline	mm	900*340*1345		
	Package	mm	998*458*1515		
Net weight/Gross weight		kg	110/120	110/120	110/120
Loading quantity	40' GP	set	57	57	57
	40' HQ	set	57	57	57

Note: The ODU operation temperature range is -5~52°C in cooling and -20~27°C in heating.

Slim 50/60 Hz

Model			CHV-5S224SNMX2	CHV-5S280SNMX2	CHV-5S335SNMX2
Capacity range		HP	8	10	12
Capacity	Cooling	kW	22,4	28	33,5
	Heating	kW	24	30	35
EER		W/W	3,66	3,6	3,5
COP		W/W	4,9	4,9	4,9
Power supply		V/Ph/Hz	380-415B~3φ-50/60Гц		
Max. circuit / Fuse current		A	20	25	32
Power consumption	Cooling	kW	6,12	7,78	9,57
	Heating	kW	4,9	6,12	7,14
Maximum drive IDU NO.		unit	13	17	20
Refrigerant Charge volume		kg	5,5	7,1	8,0
Sound pressure level		dB(A)	60	62	63
Connecting pipe	Жидкость	mm	Φ9,52	Φ9,52	Φ12,7
	Газ	mm	Φ19,05	Φ22,2	Φ25,4
Dimension(WxDxH)	Без упаковки	mm	940x320x1430	940x460x1615	940x460x1615
	В упаковке	mm	1038x438x1580	1038x578x1765	1038x578x1765
Net weight/Gross weight		kg	133/144	166/183	117/194
Loading quantity	40' GP	set	56	44	44
	40' HQ	set			

Note: The ODU operation temperature range is -5~52°C in cooling and -20~27°C in heating.

CHV5 Max



Key features

DC inverter technology to improve compression efficiency.

DC inverter compressor and high-performance high pressure chamber are adopted to reduce loss of overheat and improve compression efficiency from direct intake. Compared with low pressure chamber, the compression efficiency is improved. High-efficient permasyon motor is adopted to provide better performance than traditional DC inverter compressor.

DC Inverter compressor

- High-performance high pressure chamber DC inverter compressor is adopted. High pressure chamber structure can directly reduce loss of overheat and improve compression efficiency, comparing with the compression efficiency of low pressure chamber.

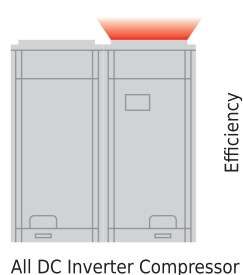

Efficiency

HP chamber structure can raise the high and middle frequency performance

New DC motor (concentrated winding) raises the low frequency performance

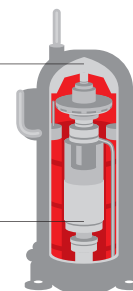

- High-efficient permasyon motor is adopted to provide better performance than traditional DC inverter compressor.

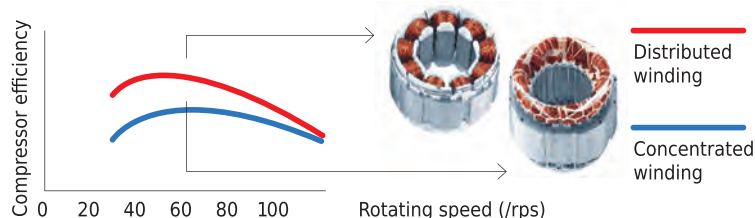

- Technology of maximum torque control with minimum current.**

It can reduce energy loss caused by device winding so as to realize higher efficiency.

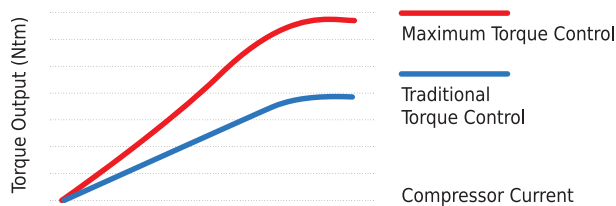

- 180° Sine Wave DC Speed Varying Technology**

It can satisfy various places' demands for different temperature and is able to save a great deal of electricity and provide users with utmost comfort at the same time.

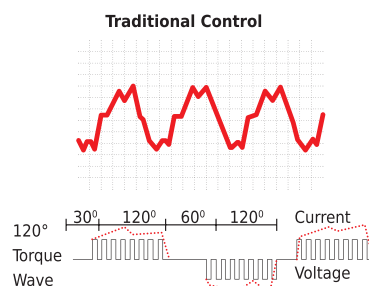

- Low-frequency Torque Control.**

It can directly control motor torque, through which fan motor can run at a low speed. Users will feel more comfortable while requirements of the system are also met.

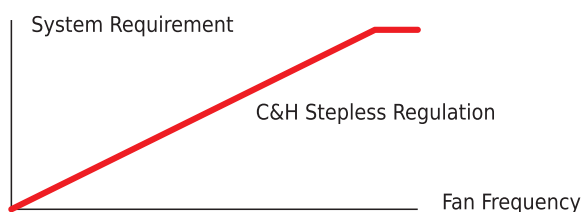

180° Sine Wave D.C. Control

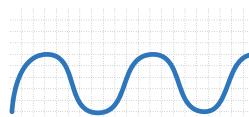

Rotator speed stepless regulation between 1200-7200 rpm

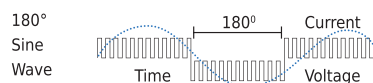

Sensorless DC inverter fan motor

- Stepless speed regulation ranges from 5Hz to 65Hz. Compared with traditional inverter motors, the operation is more energy-saving.

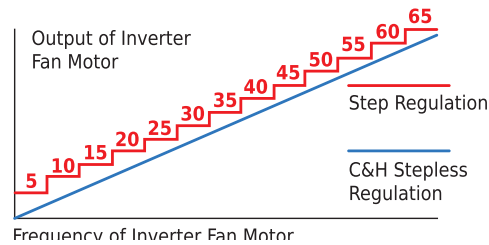

- Sensorless control technology guarantees lower noise, less vibration and steadier operation.

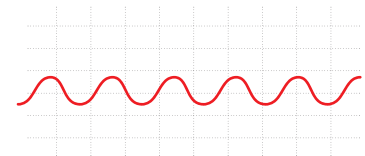
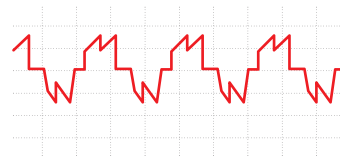

Before

After

Wide range of operation condition

- Outdoor operation temperature range is improved to -5°C~52°C in cooling and -20°C~24°C in heating.

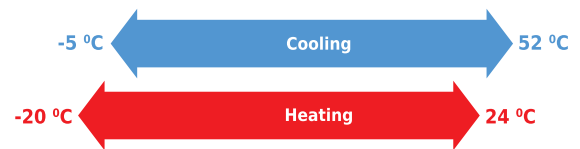

Sub-cooling control technology to ensure optimal cooling and heating

- Heat exchange loop can control the first subcooling process of heat exchanger. Subcooling degree can reach 11°C.

- Subcooling loop can realize 9 °C second subcooling to guarantee cooling and heating performance.

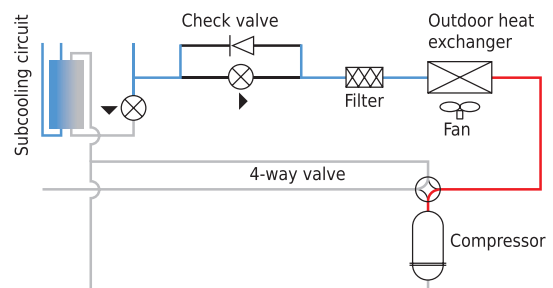
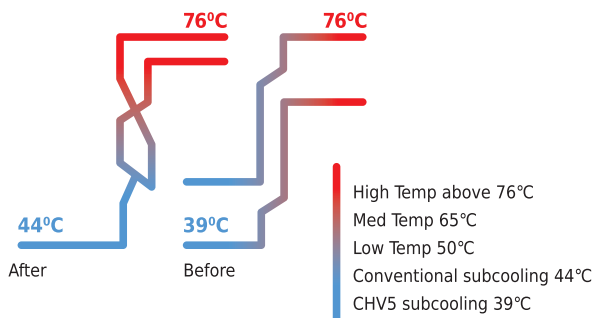

High efficiency and more energy saving

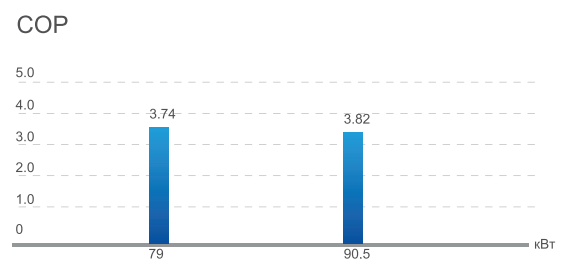
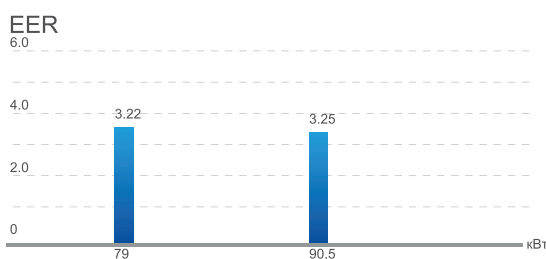

Energy-saving operation control technology

The CHV5 MAX system has 2 modes for energy saving, which can be chosen to meet different electricity demands.

Mode 1:

When unit is set in auto energy-saving mode, it will automatically adjust the parameters of control targets according to running status so as to achieve lower power consumption.

Mode 2:

When unit is set in compulsory energy-saving mode, it will limit system power out putina compulsory way.

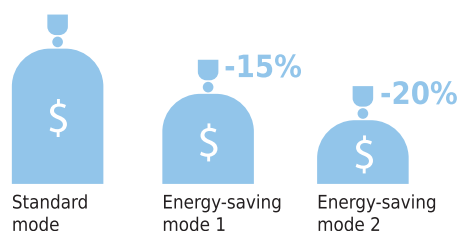

G-type heat exchanger

G-type heat exchanger fully utilizes the turning angle and vertical space to ensure sufficient heat exchange area. Stream heat exchange features high control precision and efficient heat exchange to guarantee satisfactory cooling and heating performance.



Intelligent defrosting control

During the heating process, the frost status of the unit will be different after affecting by factors of outdoor ambient temperature, load status and operation time. Through real-time detection of operation parameters of the system, it can decide the defrosting time by intelligently estimating the thickness of frost, high pressure of system and blockage status of heat exchanger.

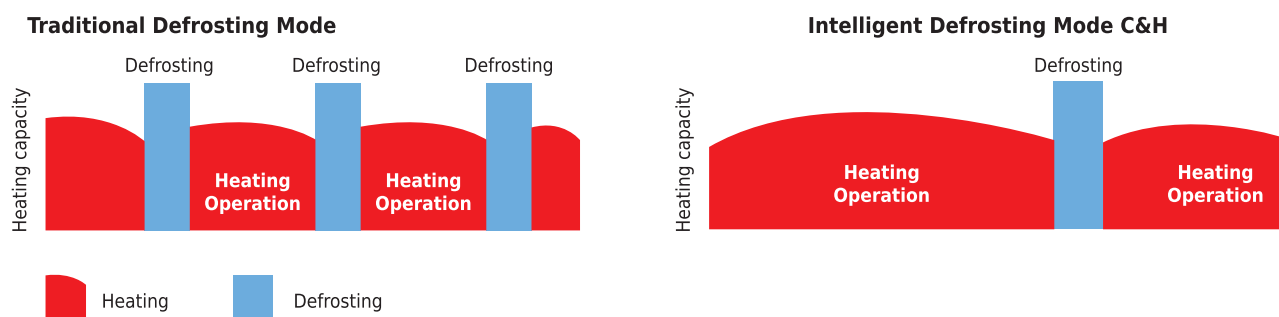

Oil return control technology

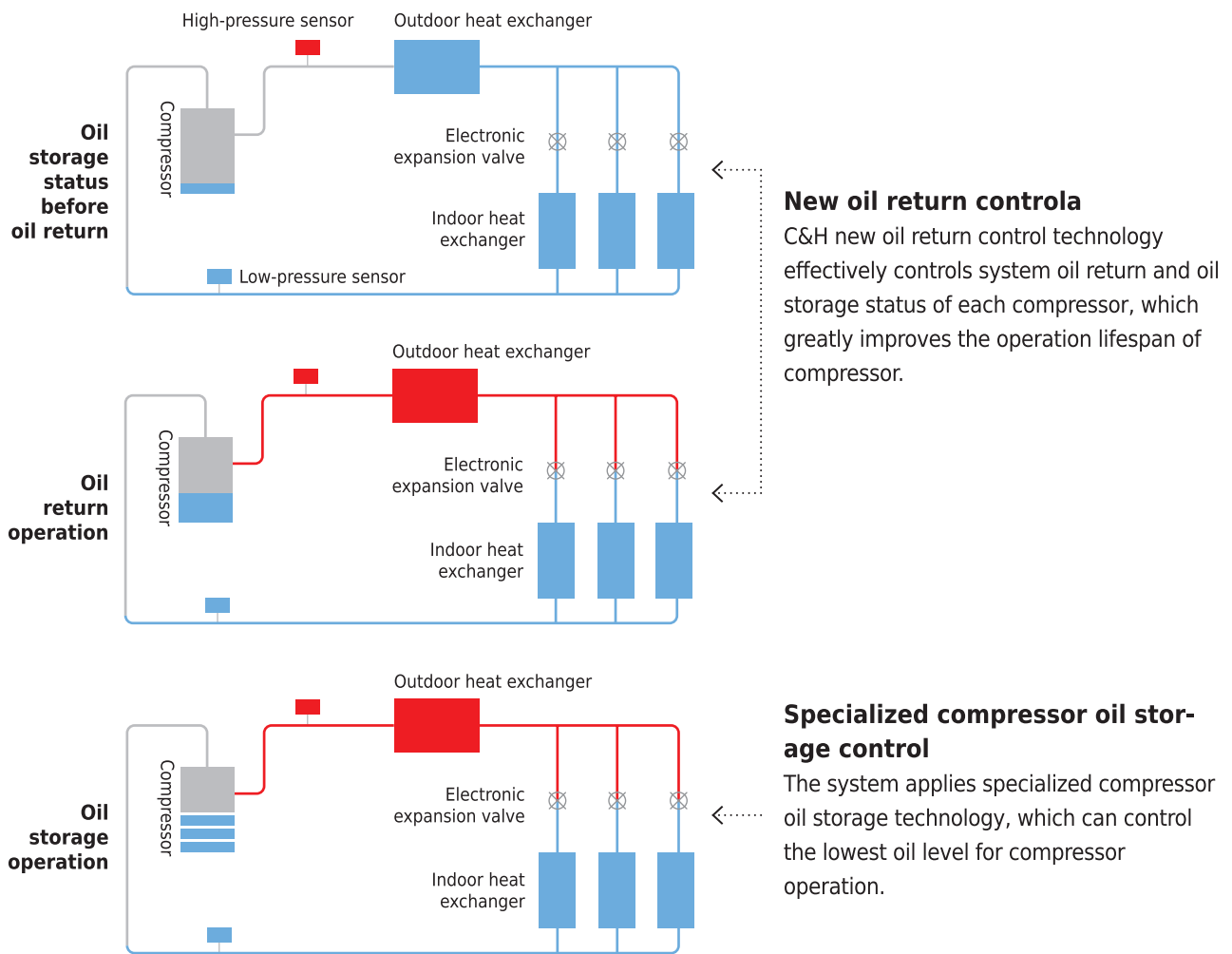

Oil circuit malfunction detection for real-time judgment and protection

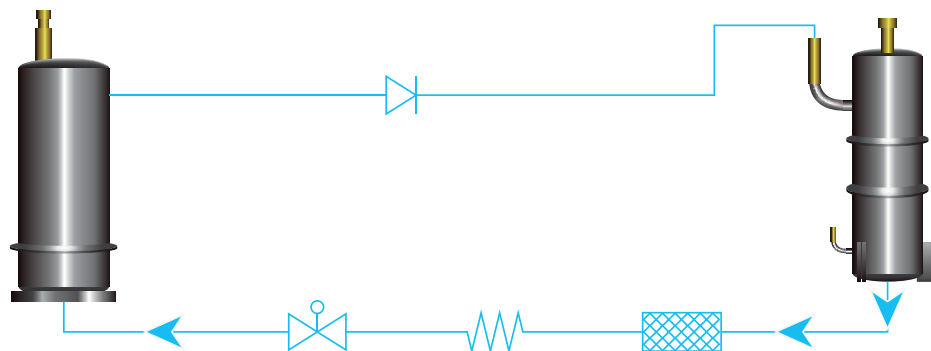

For CHV5 MAX, detection sensor is designed for the oil supply circuit of each compressor. This is to realize real-time judgment and detection for the oil supply circuit. When the compressor oil supply circuit is malfunctioning, shutdown protection will be enabled immediately to avoid further damage to the compressor. Maintenance cost for the system is reduced.

Engineering debugging for convenient construction

MAX has five auto debugging features:

1. Automatic allocation of IDU and ODU addresses
2. Automatic detection of IDU and ODU quantity
3. Automatic detection of errors
4. Automatic start-up of debugging
5. Real-time judgment of pipe errors

Excellent emergency operation function to ensure reliable operation

➤ Emergency operation of compressor

All the compressors in each single module are DC Inverter based, when one compressor has error, others will perform the emergency operation.

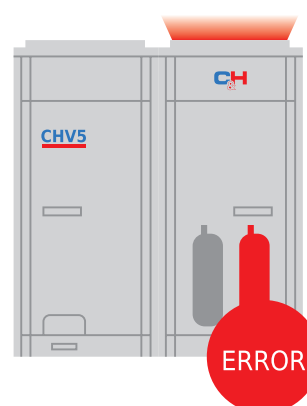

➤ Emergency operation of fan

Double-fan design ensures that one fan can still work even if the other one has error.



Outdoor unit quiet mode and quiet control

Quiet at night

The system can record the highest outdoor temperature. At night, the system will automatically turn to quiet mode. There are 9 quiet modes which can be set according to actual needs.

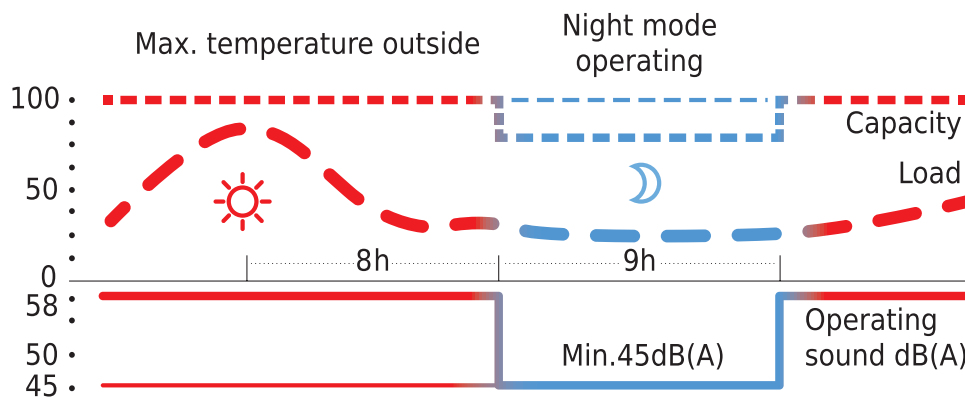

Quiet in compulsion

The system can also be set in this mode to ensure low noise as long as it is operating. Noise is as low as 45dB(A).

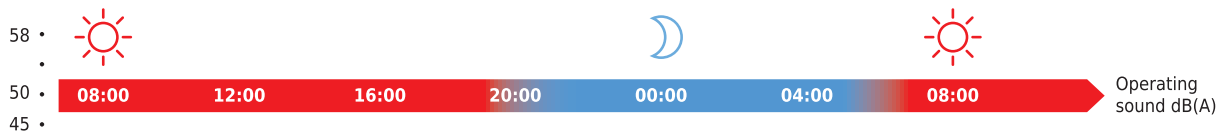

Quiet Control

1. Optimized Bossing Design.

After many times of CFD tests, a new fan bossing structure has been developed to reduce vibration of fan during run ning. Noise can be reduced by 3dB(A).

2. Aerodynamics 3D Axial Fan.

Compared with conventional fan, it can increase a i r volume by 12%, improving efficiency as well as lowering noise.

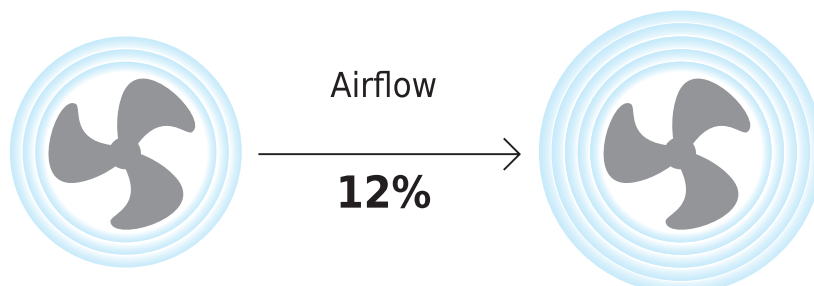

MAX Lineup

kW	Model	Product
78,5	CHV-5S785MX	
90	CHV-5S900MX	

Max 50/60 Hz

Model			CHV-5S785MX	CHV-5S900MX
Capacity range		HP	28	32
Capacity	Cooling	kW	78,5	90
	Heating	kW	87,5	100
EER		kW / kW	3,22	3,25
COP		kW / kW	3,74	3,82
Power supply		V/Ph/Hz	380-415V-3Ph-50Hz	
Max. Circuit/Fuse Current		A	57,2/63	71,5/80
Power consumption	Cooling	kW	24,4	26,2
	Heating	kW	23,4	53
Maximum drive IDU NO.		unit	46	24
Refrigerant Charge volume		kg	18,9	24
Sound pressure level		dB(A)	65	65
Connecting pipe	Liquid	mm	Φ19,05	Φ19,05
	Gas	mm	Φ31,8	Φ31,8
Dimension (WxDxH)	Outline	mm	2200x880x1675	
	Package	mm	2267x952x1867	
Net weight/Gross weight		kg	557/592	600/635
Loading quantity	40' GP	set	12	12
	40' HQ	set	12	12



CHV5 Heat Recovery



Key features

High efficiency

CHV5 Heat Recovery System embodies the excellent features of CHV5 (DC inverter technology, DC fan linkage control, precise control of capacity output, balancing control of refrigerant, original oil balancing technology with high pressure chamber, high-efficiency output control, low-temperature operation control technology, super heating technology, high adaptability for project, environmental refrigerant). Its energy efficiency is improved by 78% compared with conventional multi VRF.

Five efficient operation modes

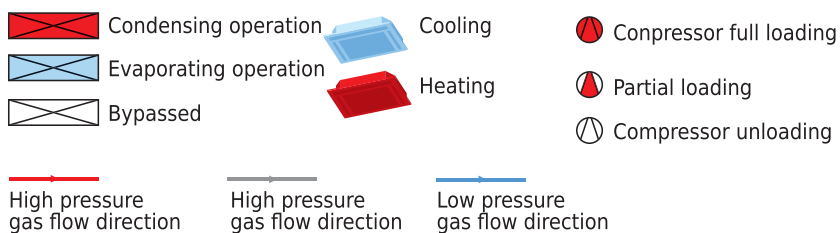
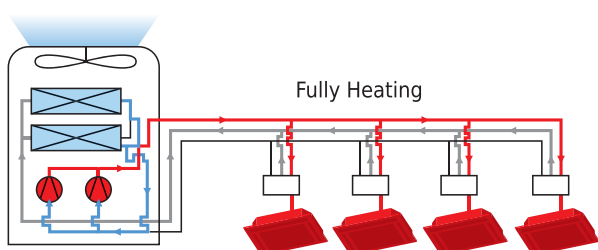
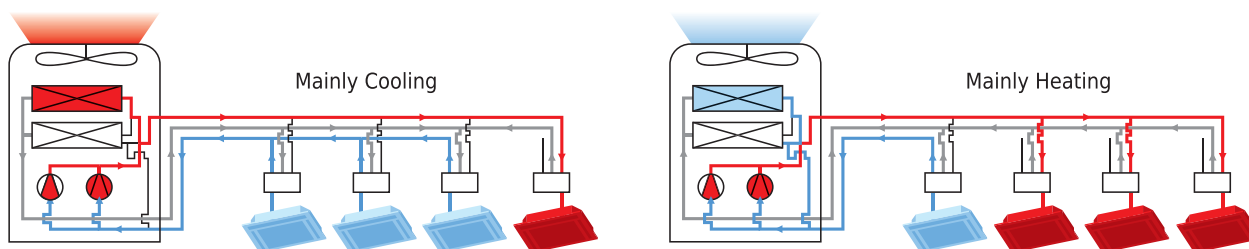
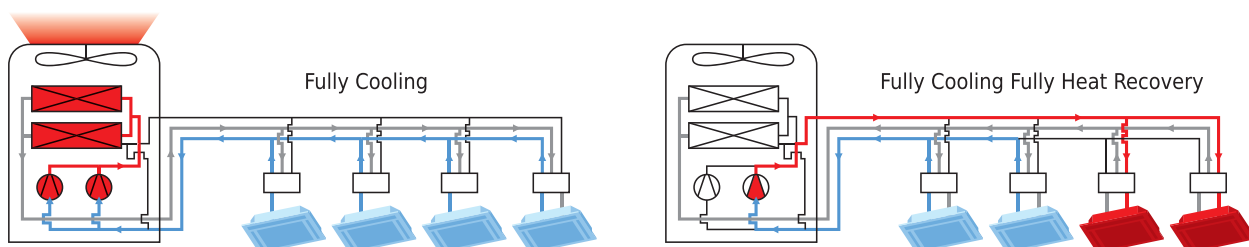

All DC inverter technology to improve compression efficiency

- All DC inverter compressor is used in this system. It can directly intake gas to reduce loss of overheat and improve efficiency.
- High-efficient permasyne motor is adopted to provide better performance than traditional DC inverter compressor.

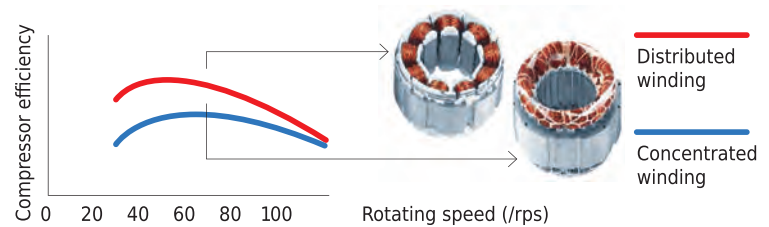

➤ High pressure chamber design

What's high pressure chamber?

The low-temperature and low-pressure refrigerant gas inhaled from the suction inlet of compressor will change to high-temperature and high-pressure gas after compression by scroll plate. Then the gas will go out from the exhaust at the center of fixed scroll and get into the lower chamber of compressor, so that the chamber of compressor is in high temperature and high pressure

What's the benefits of high pressure chamber?

High pressure chamber compressor inhales directly to reduce overheat suction loss and improve compression efficiency.

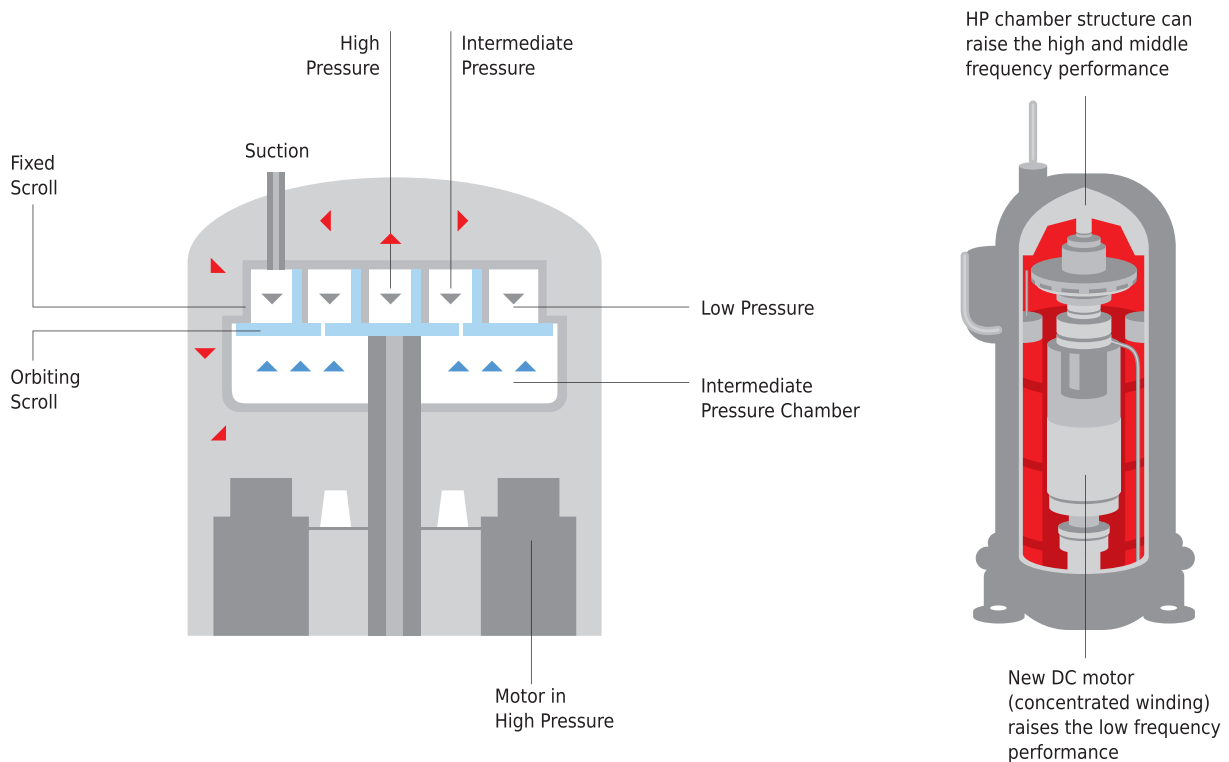

➤ Sensorless DC inverter fan motor

Stepless speed regulation ranges from 5Hz to 65Hz. Compared with traditional inverter motors, the operation is more energy-saving.

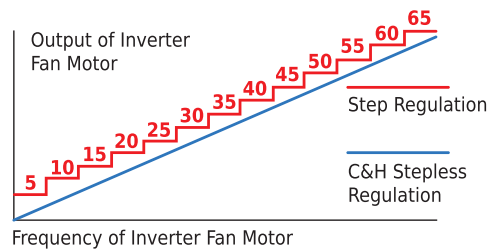

➤ Sensorless control technology guarantees lower noise, less vibration and steadier operation.

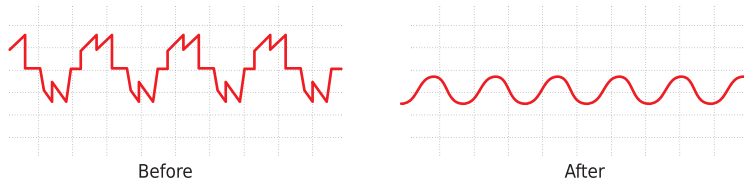

Wide range of voltage to ensure a steady system running

Working voltage range of CHV5 system has been improved to 320V-460V, which surpasses the national standard of 342V-420V. For places with unsteady voltage, this system can still be running well

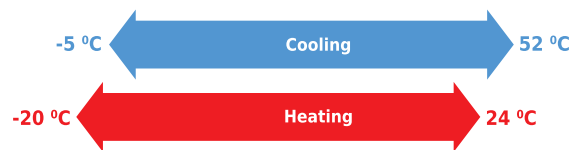

Wider applicable location

CHV5 can realize a combination of 4 outdoor unit modules connecting with as many as 80 indoor units. It's especially applicable for business building or hotels.

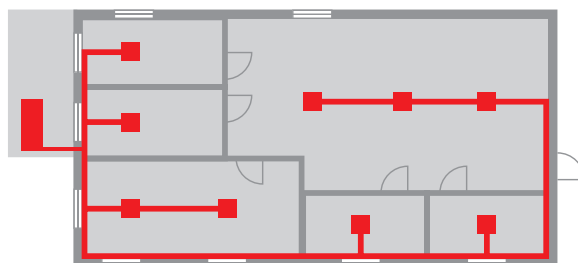

Max. IDU Connection: 80 sets



Smart user's functions

Outdoor unit quiet mode and quiet control

▶ Quiet at night

The system can record the highest outdoor temperature. At night, the system will automatically turn to quiet mode. There are 9 quiet modes which can be set according to actual needs.

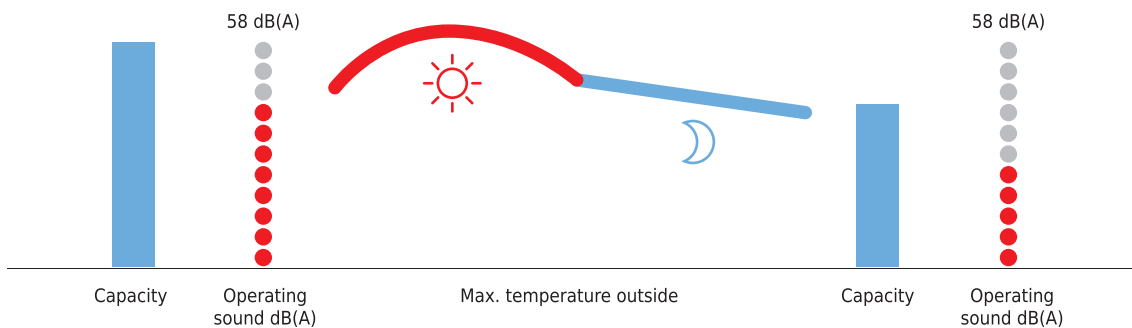

▶ Quiet control

The high-pressure chamber compressor has a lower vibration level of output pressure, as result it reducing the total noise level.

Optimized bossing design after many times of CFD tests, a new fan bossing structure has been developed to reduce vibration of fan during running.

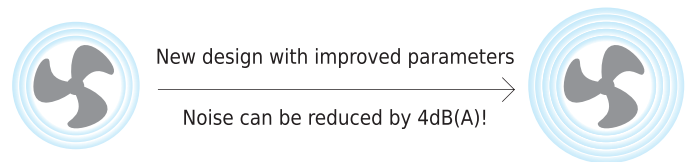
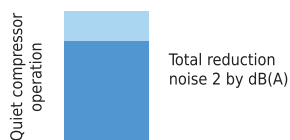

Energy-saving individual control

Required room temperature can be set different for every room, thanks to individual control by IDU thermostat. Simultaneously, the unit can operate at heating and cooling mode.

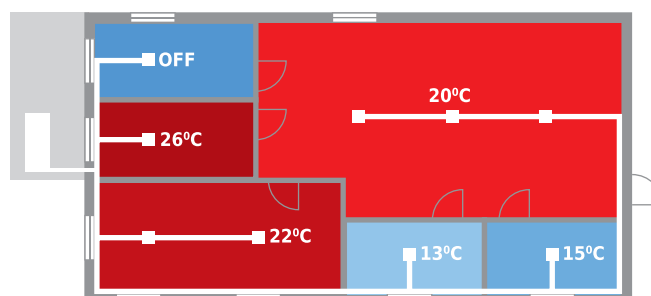

Wide operation range

The unit can operate in wide operating range, which is makes possible to increase outside temperature working range.

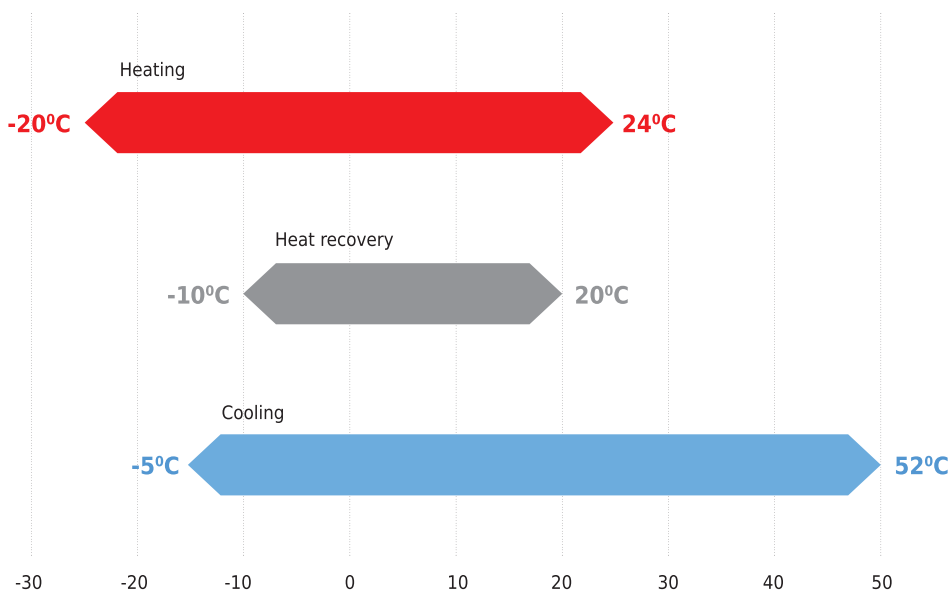

Note:
If required IDU capacity higher by 50% than ODU capacity, heating temperature range can be expanded up to -15°C.

If required IDU capacity higher by 50% than ODU capacity, cooling temperature range can be expanded up to -5°C.

Intelligent defrosting control

During the heating process, the frost status of the unit will be different after affecting by factors of outdoor ambient temperature, load status and operation time. Through real-time detection of operation parameters of the system, it can decide the defrosting time by intelligently estimating the thickness of frost, high pressure of system and blockage status of heat exchanger.

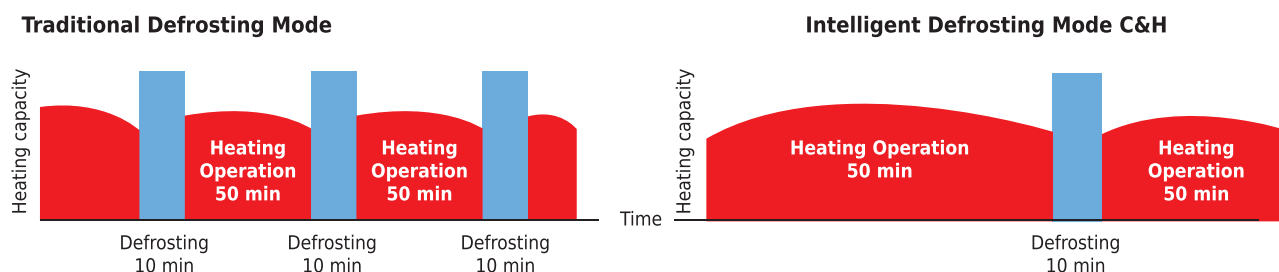

Note: This feature is fit for heat pump models only.



Innovative technologies provides perfect technical characteristics

Modules rotation operating to maximize lifespan



Modules 8h rotation operating

The operating priority sequence of the outdoor unit modules will be changed without restart when the system accumulatively operates for 8 hours, which can maximize the service life of the system.

Excellent emergency operation function to ensure reliable operation

Emergency function

The CHV5 system can realize a combination of 4 outdoor unit modules. When error is occurred to one of the modules, the others will perform the emergency operation to sustain the air conditioning.

Emergency operation of compressor

All the compressors in each single module are DC Inverter based, when one compressor has error, others will perform the emergency operation.

Emergency operation of fan

Double-fan design fan ensures that one fan can still work even if the other one has error.

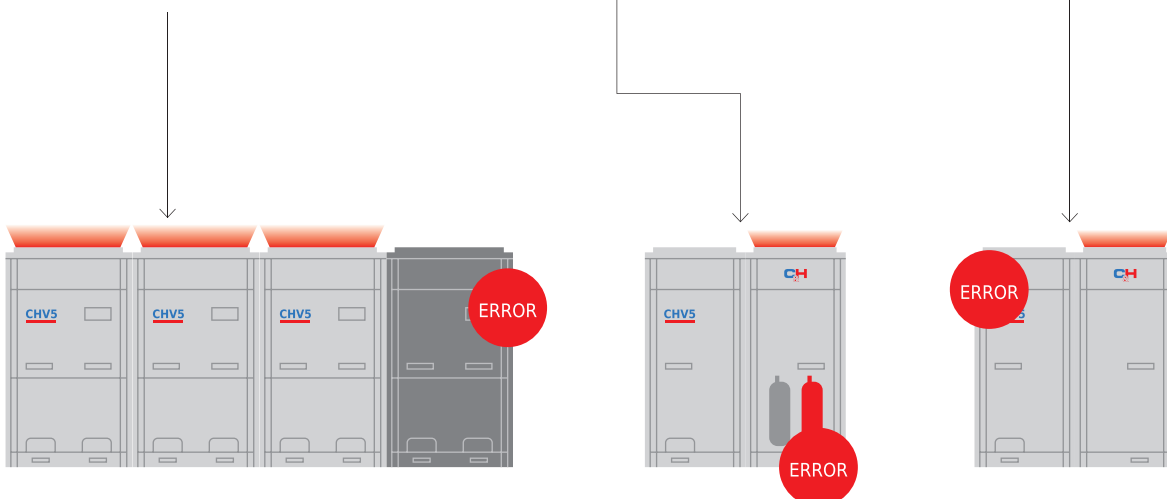

Highly anticorrosive golden fins

The primary material of Golden Fin is Al-Mn (Aluminum-Manganese) anti-rust alloy, which is coated with the Golden Protection Layer (Components: Epoxy Resin & Modified Acrylic, Silicon free), the anti-corrosive performance in salt-spray testing is 200%~300% higher than normal Blue Fin*.

Note: Salt-spray testing result is from C&H materials chemistry testing laboratory.

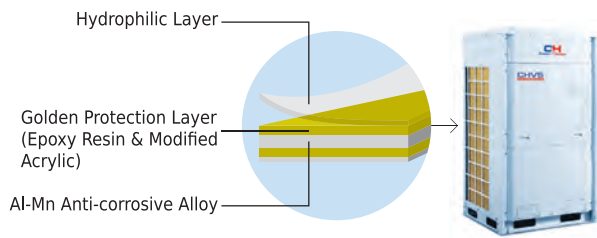

Oil return control technology

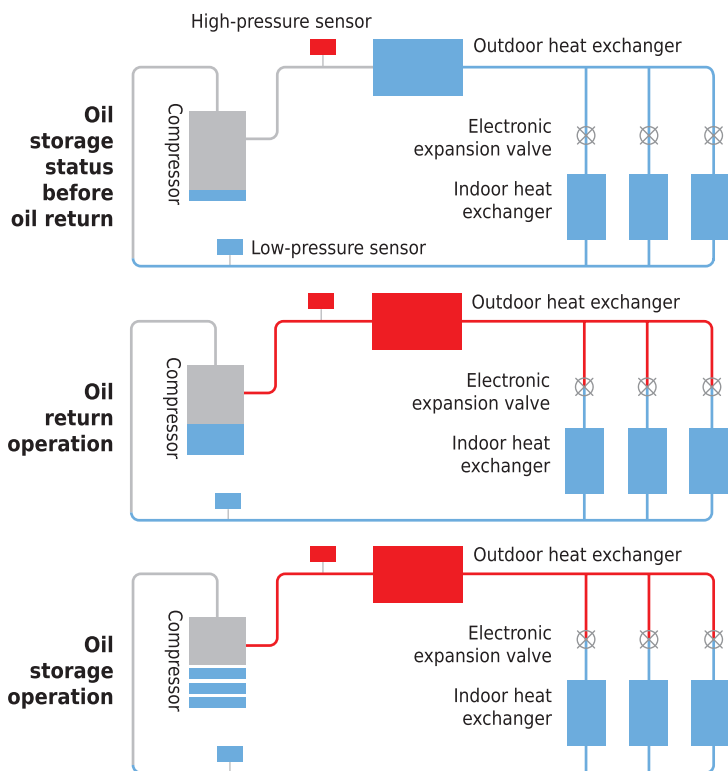

New oil return control

C&H new oil return control technology effectively controls system oil return and oil storage status of each compressor, which greatly improves the operation lifespan of compressor.

Specialized compressor oil storage control

The system applies specialized compressor oil storage technology, which can control the lowest oil level for compressor operation.

Without external oil-balanced pipe design

The unit is without external oil-balanced pipe design, reducing system pipeline connection and easy for engineering installation. The system will allocate lubricating oil of each module according to its demand, which is more intelligent, more efficient and more equal.

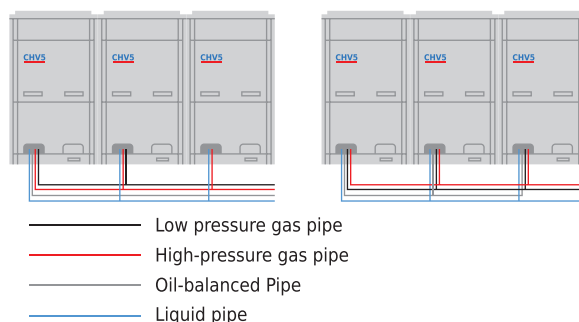



Easy installation and maintenance

Compact design

With compact design, the outdoor unit can be carried to the roof of building through elevator, with no need of crane. It is easier for delivery and installation.

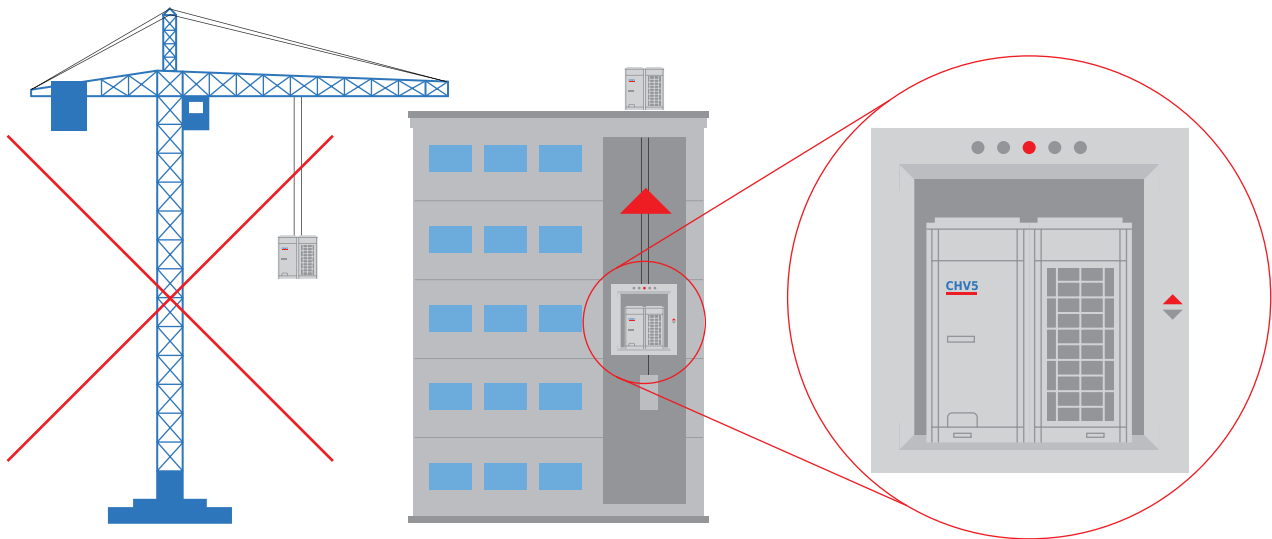

Easy Transportation

➤ Transportable by forklift

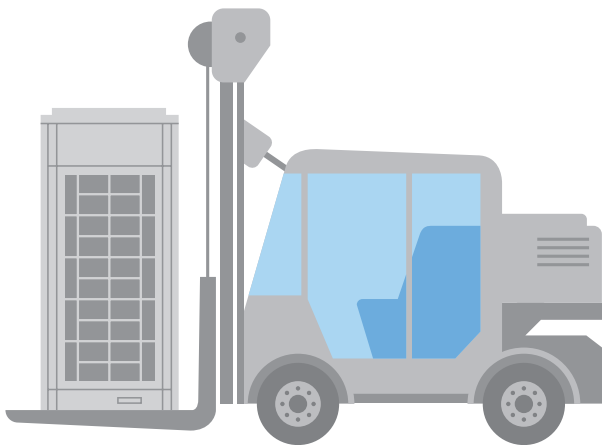

➤ Five-way piping connection

Piping and wiring are available to the front and back, left and right, and bottom. The five-way piping connection reduces installation difficulty and cost, improves the installation efficiency.

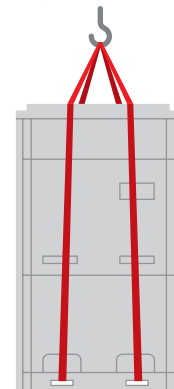

➤ Easy maintenance

Inspection window is available for quick checking of system operation status. No need to open panel for checking, which will be more time-saving and easier for maintenance.

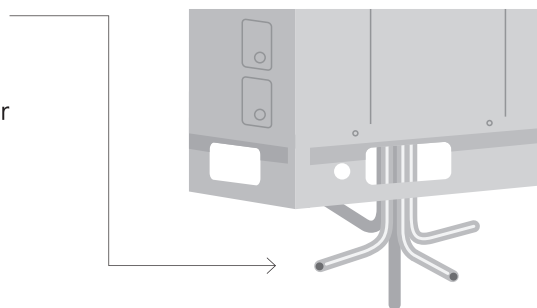

Easy maintenance

- Inspection window is available for quick checking of system operation status. No need to open panel for checking, which will be more time-saving and easier for maintenance.

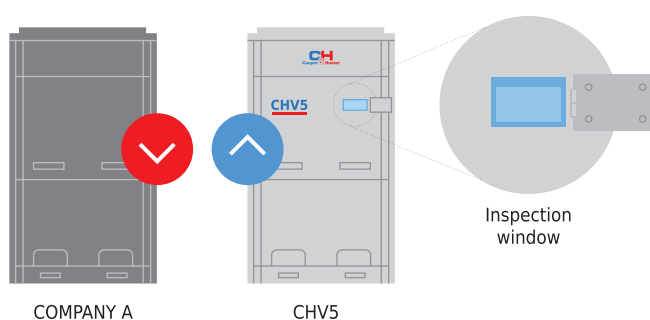

➤ Error display & self-diagnostic function

Through LED display(different combinations of ON, OFF, or BLINK) on the main board, the malfunction can be judged.





Lineup HR CHV5

Lineup HR

kW	Model	Product
22,4	CHV-5SH224NMX	
28	CHV-5SH280NMX	
33,5	CHV-5SH335NMX	
40	CHV-5SH400NMX	
45	CHV-5SH450NMX	

Model	Product
HRB1NK	
HRBS4NK	
HRBS8NK	

Specifications and Parameters

50/60Hz

Model			CHV-5SH224NMX	CHV-5SH280NMX	CHV-5SH335NMX	CHV-5SH400NMX	CHV-5SH450NMX
Capacity range		HP	8	10	12	14	16
Capacity	Cooling	kW	22,4	28	33,5	40	45
	Heating	kW	25	31,5	37,5	45	50
EER		kW/kW	4,07	3,73	3,76	3,54	3,33
COP		kW/kW	4,17	3,89	3,68	3,85	3,62
IPLV	Cooling	kW/kW	/	/	/	/	/
Power supply		V/Ph/Hz	380-415V 3N~50/60Hz				
Max. circuit/Fuse current		A	15.7/20	20.9/25	24,7/32	28,8/40	33,2/40
Power consumption	Cooling	kW	5,5	7,5	8,9	11,3	13,5
	Heating	kW	6	8,1	10,2	11,7	13,8
Maximum drive IDU NO.		unit	13	16	19	23	26
Refrigerant charge volume		kg	6.2	7,1	8,6	10,2	10,5
Sound pressure level		dB(A)	60	61	63	63	63
Connecting pipe	Liquid	mm	Φ9,52			Φ12,7	
	Gas	mm	Φ19,05	Φ22,2	Φ25,4		Φ28,6
	Oil balance	mm	Φ19,05			Φ22,2	
Dimension (WxDxH)	Outline	mm	930*765*1605			1340*765*1605	
	Package	mm	1010*840*1775			1420*840*1775	
Net weight/Gross weight		kg	233/243	233/243	303/318	360/375	360/375
Loading quantity	40' GP	set	24	24	16	16	16
	40' HQ	set	24	24	16	16	16

50Hz

Model			HRB1NK	HRB2NK	HRBS4NK	HRBS8NK
Max.IDU branches		unit	1	2	4	8
No. of connectable IDU of each branch		unit	8	8	8	8
Total connectable IDU		unit	8	16	32	64
Max. capacity of each branch		kW/kW	14	14	14	14
Max. capacity of connectable IDU		kW/kW	14	28	45	65
Power supply		V/Ph/Hz	220-240V-1N-50Hz			
Power consumption		kW	20	28	30	30
Max. branch quantity of connecting IDU		unit	1	2	4	8
Outdoor unit piping connection	Liquid	mm	Φ9.52	Φ9,52	Φ12.7	Φ15.9
	Gas(Low pressure)	mm	Φ22,2	Φ22,2	Φ28,6	Φ28,6
	Gas(High pressure)	mm	Φ19.05	Φ22,2	Φ28,6	Φ28,6
Indoor unit piping connection	Liquid	mm	Φ9.5	Φ22.2	Φ9.5	Φ9.5
	Gas	mm	Φ15.9	Φ22.2	Φ15.9	Φ15.9

Corrosive resistant covered unit CHV5 P



Key features

High Corrosion Resistant

The unit has special epoxy layer for every component to work at seaside area.

High efficiency and more energy saving

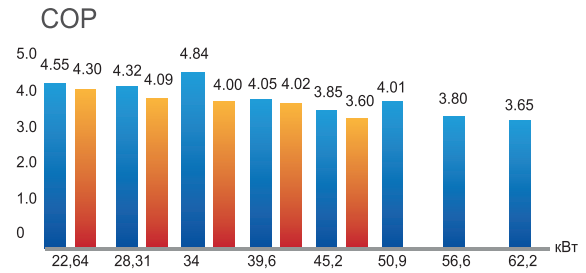
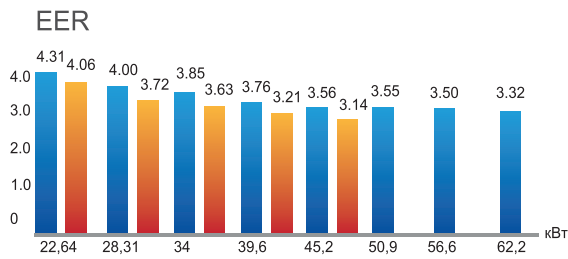

➤ Thanks to innovative technologies, the efficiency increase in heating and cooling mode.

Max capacity is 249 kW —the largest free combination

Max capacity of single outdoor unit reaches 62 kW, and max combination capacity is even up to 249 kW, in an industry leading level.

Max combination capacity is extended to 249 kW



High corrosion resistant

The plastic planting grille protects against salt. All panel parts are corrosion resistant to protect against brine.

Corrosion resistant heat-exchange fins are suitable for seaside areas and exposed to acidic substances.

All screws are anti-rust.

All PCB parts in the unit are coated with three proofing glue. The outer side of the control box metal cover is the spray-painted.

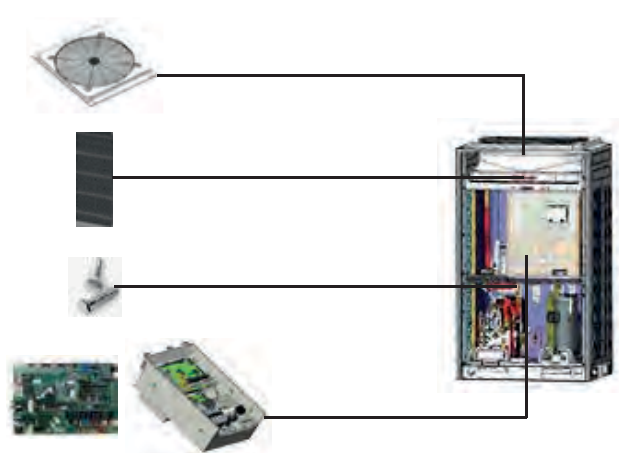

Engineering debugging for convenient construction

CHV P has five auto debugging features::

1. Automatic allocation of IDU and ODU addresses;
2. Automatic detection of IDU and ODU quantity;
3. Automatic detection of errors;
4. Automatic start-up of debugging;
5. Real-time judgment of pipe errors.

Intelligent defrosting control

During the heating process, the frost status of the unit will be different after affecting by factors of outdoor ambient temperature, load status and operation time. Through real-time detection of operation parameters of the system, it can decide the defrosting time by intelligently estimating the thickness of frost, high pressure of system and blockage status of heat exchanger.

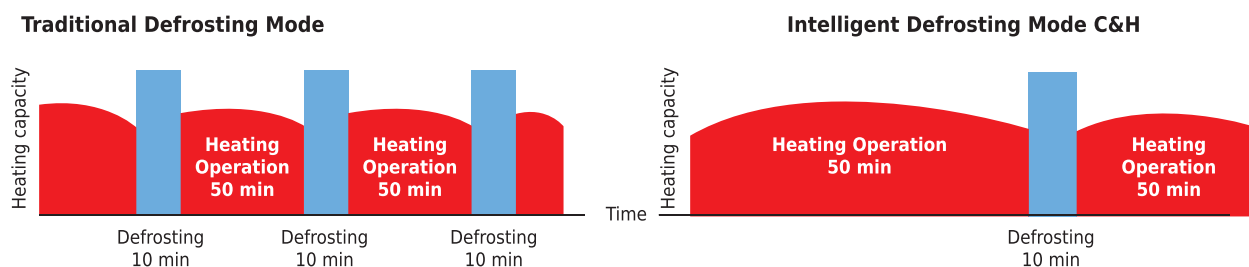

Note: This feature is fit for heat pump models only.

New generation of energy-saving operation control technology with energy saving up to 20% Saving Up to 20%

The CHV5 system has 2 modes for energy saving, which can be chosen to meet different electricity demands..

Mode 1:

In auto energy-saving mode, the system will self-adjust parameters according to the operation status, thus to lower the cost of electricity. Up to 15% of energy can be saved.

Mode 2:

In compulsory energy-saving mode, the system will limit power output forcibly. Up to 20% of energy can be saved..

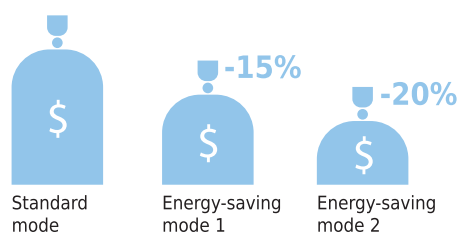

Smart troubleshooting technology for convenient installation and start-up the unit

Five-way piping connection

Piping and wiring are available to the front and back, left and right, and bottom.

The five-way piping connection reduces installation difficulty and cost, improves the installation efficiency.

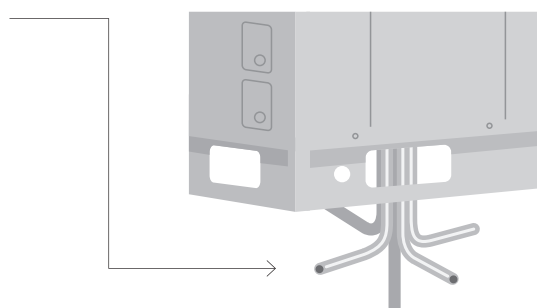





Specifications and parameters

ODU Combination Lineup

	CHV-5SP224NMX	CHV-5SP280NMX	CHV-SP335NMX	CHV-SP400NMX	CHV-SP450NMX	CHV-SP504NMX	CHV-SP560NMX	CHV-SP615NMX
CHV-5SP224NMX	•							
CHV-5SP280NMX		•						
CHV-5SP335NMX			•					
CHV-5SP400NMX				•				
CHV-5SP450NMX					•			
CHV-5SP504NMX						•		
CHV-5SP560NMX							•	
CHV-5SP615NMX								•
CHV-5SP680NMX		•		•				
CHV-5SP730NMX		•			•			
CHV-5SP785NMX		•				•		
CHV-5SP850NMX		•					•	
CHV-5SP900NMX		•						•
CHV-5SP960NMX			•					•
CHV-5SP1010NMX				•				•
CHV-5SP1065NMX					•			•
CHV-5SP1130NMX						•		•
CHV-5SP1180NMX							•	•
CHV-5SP1235NMX								••
CHV-5SP1300NMX		•			•		•	
CHV-5SP1350NMX		•			•			•
CHV-5SP1410NMX			•		•			•
CHV-5SP1460NMX		•					•	•
CHV-5SP1515NMX		•						••
CHV-5SP1580NMX			•					••
CHV-5SP1630NMX				•				••
CHV-5SP1685NMX					•			••
CHV-5SP1750NMX						•		••
CHV-5SP1800NMX							•	••
CHV-5SP1854NMX								•••
CHV-5SP1908NMX		•			•		•	•
CHV-5SP1962NMX		•				•	•	•
CHV-5SP2016NMX		•					••	•
CHV-5SP2072NMX		•					•	••
CHV-5SP2128NMX		•						•••

	CHV-5SP224NMX	CHV-5SP280NMX	CHV-SP335NMX	CHV-SP400NMX	CHV-SP450NMX	CHV-SP504NMX	CHV-SP560NMX	CHV-SP615NMX
CHV-5SP2184NMX			•					•••
CHV-5SP2240NMX				•				•••
CHV-5SP2295NMX					•			•••
CHV-5SP2350NMX						•		•••
CHV-5SP2405NMX							•	•••
CHV-5SP2460NMX								••••

Lineup

kW	Model	Product
22,64	CHV-5SP224NMX	
28,3	CHV-5SP280NMX	
33,5	CHV-5SP335NMX	
40	CHV-5SP400NMX	
45,28	CHV-5SP450NMX	
51	CHV-5SP504NMX	
56,6	CHV-5SP560NMX	
62,2	CHV-5SP615NMX	

Specifications and parameters

50/60 Hz

Model			CHV-5SP224NMX	CHV-5SP280NMX	CHV-5SP335NMX	CHV-5SP400NMX
Capacity range		HP	8	10	12	14
Capacity	Cooling	kW	22,4	28	33,5	40
	Heating	kW	25	31,5	37,5	45
EER		kW / B _T	4,31	4,00	3,85	3,76
COP		kW / kW	4,55	4,32	4,84	4,05
IPLV	Cooling	kW / kW	/	/	/	/
Power supply		V/Ph/Hz	380-415V-3Ph-50Hz/60Hz			
Max. circuit / Fuse current		A	15,7/20	20,9/25	22,5/32	28,8/40
Power consumption	Cooling	kW	5,2	7	8,7	10,65
	Heating	kW	5,5	7,3	7,75	11,1
Maximum drive IDU NO.		unit	13	16	19	23
Refrigerant charge volume		kg	5,9	6,7	9	9,8
Sound pressure level		dB(A)	60	61	61	63
Connecting pipe	Liquid	mm	Φ9,52		Φ12,7	
	Gas	mm	Φ19,05	Φ22,2	Φ25,4	
	Oil balance	mm	Φ19,05			Φ22,2
Dimension (W*D*H)	Outline	mm	930*765*1605			1340*765*1605
	Package	mm	1010*840*1775			1420*840*1775
Net weight / Gross weight		kg	225/235	225/235	235/250	360/375
Loading quantity	40' GP	set	24	24	24	16
	40' HQ	set	24	24	24	16



Key features of indoor units

High static pressure duct type indoor unit



High static pressure design

Static pressure can be up to 150Pa, especially suitable for places in need of long distance airflow.

Convenient installation

You can choose circular air duct or rectangular air duct according to actual needs. Or you can choose different ways of air return.

Easy maintenance

The system has maintenance port for easy maintenance.

Protection function

Anti-freezing protection, fan motor overload protection, temperature sensor malfunction protection.

Low static pressure duct type indoor unit



➤ Low static pressure, low noise

Especially suitable for rooms of compact structure or small installation space. Also, it provides you with a comfortable and quiet living environment.

➤ Intelligent drainage device

Water height difference up to 1.0m, which can effectively drain out condensing water and save space.

Note: Please specify if you need this function.

➤ Convenient installation

Tab type plastic filter, detachable fan motor, independent water pump assembly and electric box assembly, all for convenient maintenance.

➤ Protection function

Water overflow protection, anti-freezing protection, fan motor overload protection, temperature sensor malfunction protection.

Slim ducted type indoor unit



➤ Highly efficient & energy-saving

High-efficiency DC brushless motor is used. Its efficiency is improved by over 30% compared with common motor. Evaporator flow path adopts simulating optimized design via the refrigeration system simulation software, which has greatly increased the heat exchange capacity of evaporator.

➤ Slim & small

The unit is only 200mm's thick and 450mm's deep. Suspended ceiling doesn't have to be very high. It is suitable for ordinary rooms.

➤ Wiring of electric control box

Mounting board of electric control box elements are arranged at both sides of the mounting board of fan motor. There is a wire-cross notch on each side so that wiring at both sides of the mounting board of fan motor is convenient and efficient. Strong and weak current are also separated to ensure the effectiveness of weak current signal transmission.

➤ Protection functions

Anti-freezing protection, fan motor built-in overload protection, temperature sensor error protection.

➤ Ultra-quiet

High-efficiency centrifugal fan and ultralow noise volute are developed with ANSYS and Fluent. They have also gained national patents. Meanwhile, inlet mute valve is adopted so that noise of the complete unit is greatly reduced.

➤ Fast & strong

Intelligent temperature control technology is adopted. Cooling/ Heating function is fast and strong so that room temperature can quickly reach set temperature.

➤ Flexible installation

Защита от обледенения, защита встроенного двигателя вентилятора от перегрузки, защита от выхода из строя датчика температуры.

➤ CAN Bus communication technology

System response speed is faster and communication is more reliable. Auto addressing, non-polar communication, free wire matching.

➤ Convenient operation & maintenance

Electric control box is attached independently so that it can be detached as a whole, which is convenient for maintenance. The installation and maintenance of fan and motor is also convenient.

4-way cassette indoor unit



➤ Strong and balanced airflow

Unit features auto operation, 4-way airflow, 7 fan speeds and strong circulating airflow.

➤ Ultra-low noise operation

DC inverter motor can realize stepless speed regulation to lower noise. Indoor unit can be set to work under auto quiet mode via wired controller.

➤ Intelligent drainage device

Water height difference up to 1.0m, which can effectively drain out condensing water and save space.

➤ DC inverter motor

With good speed regulation performance, motor efficiency improved by 30% v.s. normal motor.

➤ Protection functio

Water overflow protection, anti-freezing protection, temperature sensor malfunction protection, fan motor overload protection.

Compact 4-way cassette indoor unit



▶ **Compact design for easy installation**

Units maintain the uniform length and width with consistent ceiling opening and panel dimension, convenient for design and installation.

▶ **Ultra-low noise operation**

DC inverter motor can realize stepless speed regulation to lower noise. Indoor unit can be set to work under auto quiet mode via wired controller.

▶ **Intelligent drainage device**

Water height difference up to 1.0m, which can effectively drain out condensing water and save space.

2-way cassette indoor unit



➤ Beautiful appearance

With beautiful and elegant front panel, it is congenial to the indoor surroundings.

➤ Intelligent drainage device

Water height difference up to 1.0m, which can effectively drain out condensing water and save space.

➤ Two-way air flow design

Two-way air outlet, to stretch air outlet distance and solve air supply problem of elongated room.

➤ Multiple protections

Anti-freezing protection, temperature malfunction protection, fan motor overload and humidity sensor protection.

1-way cassette indoor unit



➤ **Small installation space**

With 185mm ultrathin design, unit can be installed in the ceiling of 19cm deep.

➤ **Detachable grille and long life filter**

Grille is detachable for easy cleaning. With durable filter, cleaning cycle is 20 times longer.

➤ **High drain pump lift**

Drain pump lift reaches 1.0m, which can effectively drain out water.

➤ **Protection function**

Water overflow protection, anti-freezing protection, fan motor overload protection, temperature sensor malfunction protection.

Wall-mounted indoor unit



➤ **Comfortable and balanced airflow, up&down air outlet**

Upairoutlet : Incooling, cool air blows out horizontally and then gradually drops.

Downairswing: Inheating, warm air blows downward and then gradually climbs up.

➤ **Triple defenders for better purification**

Mildew-proof filter, electrostatic fibre and anti-biotic fibre adopted to remove dust, smell, bacteria and mildew.

➤ **Cold air prevention design**

During heating in winter, cold air prevention function is enabled so that air won't be blown out until it's warm.

➤ **Multiple protections**

Anti-freezing protection, temperature sensor malfunction protection, fan motor overload protection.

Floor ceiling type indoor unit



➤ **Hoisted or seated, flexible installation**

Unit can be hoisted or seated. When seated, suspended ceiling is not needed.

➤ **Beautiful appearance**

With beautiful and elegant front panel, it is congenial to the indoor surroundings.

➤ **Protection function**

Anti-freezing protection, temperature sensor malfunction protection, fan motor overload protection

➤ **Horizontal and vertical air swing**

Wider air swing range for your comfortable working and living environment.

Console indoor unit



➤ Multiple fan speed

The fan can operate at multiple speeds and satisfy different air flow volume requirements.

➤ Detachable grille and long life filter

Grille is detachable for easy cleaning. With long life filter, cleaning cycle is 20 times longer.

Floor standing indoor unit



➤ **Wide application**

It can be widely adopted in hotels, restaurants, offices, etc.

➤ **Auto clean to ensure a healthy life**

After turning off the unit, the indoor fan will keep running at a low speed for a moment to dry the inner components and parts, in order to prevent mildew and keep user healthy.

Fresh air processing indoor unit

Airflow volume: 1200~4000m³/h

Applicable range: Residential houses, villas, business buildings, hotels, apartments, etc



One system, two functions

Adopted with DC inverter technology, Fresh Air DC Inverter Multi VRF System features air conditioning function and fresh air function.

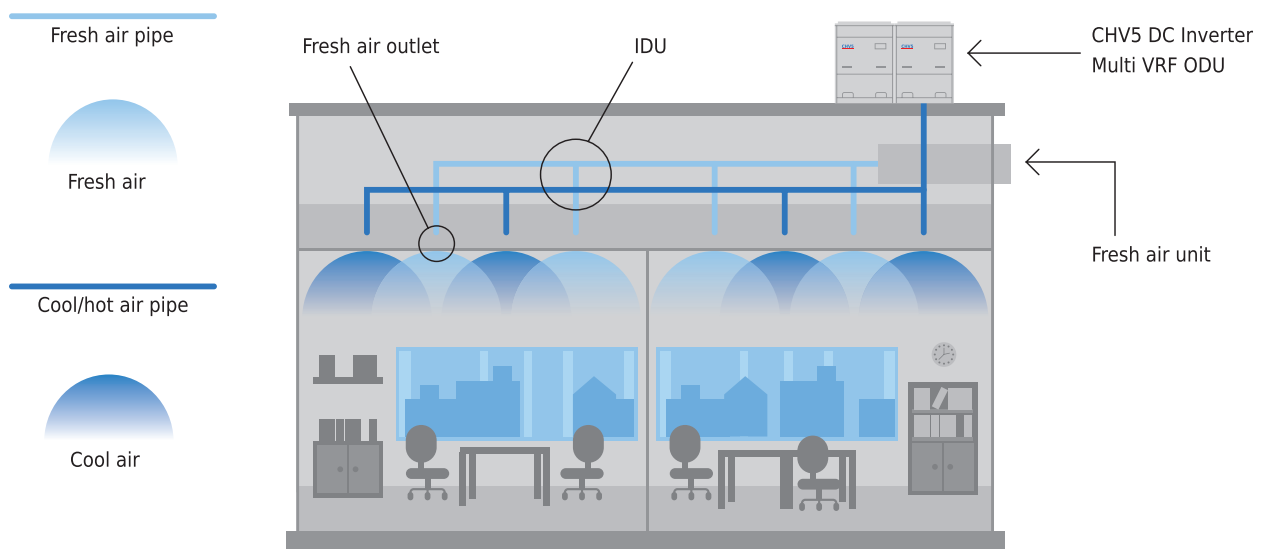

Enjoy fresh air!

- Airflow volume: 1200~4000m³/h, cooling capacity: 14-45kW Applicable for all kinds of structure.
- Direct evaporative cooling adopted, air conditioning+fresh air can be realized accurately.
- DC inverter technology adopted, constant humidity is enabled with less power consumption.
- Integrated system control with C&H CHV5 Multi VRF System.

AHU KIT

- **Multiple installation methods, convenient for engineering design.**
- **Independent design, convenient for installation.**
- **Wide capacity range, applicable to most occasions.**
- **Malfunction signal access, safe and reliable operation.**
- **VRF outdoor unit as the cold/heat source, no need of additional cold/heat source.**
- **Connected to variable refrigerant control system, with DC inverter control technology.**
- **Run together with VRF indoor units in the same system.**



Air handler

- **Multiple fan speed**
The fan can operate in multiple speed and satisfy different air flow volume requirements.
- **DC inverter motor**
With good speed regulation performance, motor efficiency improved by 30% vs. normal motor.
- **Ultra-low noise operation**
DC inverter motor can realize stepless speed regulation to lower noise. Indoor unit can be set to work under auto quiet mode via wired controller.





Indoor units lineup

Specifications of indoor units

Type of indoor unit	Specification	22	25	28	32	36	40	45	50	56	63	71	72	80	90	100	112	125	140	160	224	280	450
High Static Pressure Duct Type Unit										•	•	•		•	•	•	•	•	•	•	•	•	
Low Static Pressure Duct Type Unit		•	•	•	•	•	•	•	•	•	•	•		•	•	•	•	•	•				
Slim Ducted Type Indoor Unit		•	•	•	•	•	•	•	•	•	•		•										
4-way Cassette Unit				•		•		•	•	•	•	•		•	•	•	•	•	•	•			
Compact 4-way Cassette Indoor Unit		•		•		•		•	•	•													
2-way Cassette Indoor Unit				•		•		•	•	•	•	•											
1-way Cassette Unit		•		•		•		•	•														
Wall-mounted Type Unit		•		•		•		•	•	•	•	•											
Floor Ceiling Type Indoor Unit				•		•			•		•	•			•		•	•	•				
Console Indoor Unit		•		•		•		•	•														
Floor Standing Type Indoor Unit																•			•				
Fresh Air Processing Indoor Unit																			•		•	•	•
Air Handler														•		•	•	•		•			

High static pressure duct type indoor Unit 50/60 Hz

Model			CHV-5SDH56NK	CHV-5SDH63NK	CHV-5SDH71NK	CHV-5SDH80NK	CHV-5SDH90NK	
Capacity	Cooling	kW	5,6	6,3	7.1	8.0	9.0	
	Heating	kW	6,3	7,1	8.0	9.0	10.0	
Power supply		V/Ph/Hz	220-240/1/50 & 208-230/1/60					
Power consumption		W	120	120	130	130	200	
Airflow volume(H/M/L)		m³/h	1000/800/600	1000/800/600	1100/900/700	1100/900/700	1700/1450/1100	
		CFM	590/471/355	590/471/355	650/530/410	650/530/410	1000/853/650	
Rated Current	Cooling	A	0,6	0,6	0.6	0.6	1.0	
	Heating	A	0,6	0,6	0.6	0.6	1.0	
ESP		A		70	100			
Sound pressure level (H/M/L)		dB(A)	44/40/36	44/40/36	45/41/37	45/41/37	46//44/42	
Connecting pipe diameter	Liquid	mm	Φ9,52	Φ9,52	Φ9.52	Φ9.52	Φ9.52	
	Gas	mm	Φ15,9	Φ15,9	Φ15.9	Φ15.9	Φ15.9	
Drain pipe	External dia.	mm	Φ25	Φ25	Φ25	Φ25	Φ25	
	Thickness	mm	2,5	2,5	2.5	2.5	2.5	
Dimension (WxDxH)	Outline	mm	1271x558x268				1229x775x290	
	Package	mm	1348x597x283				1338x877x305	
Net weight/Gross weight		kg	35/40	35/40	35/40	35/40	47/54	
Loading quantity	40' GP	set	192	192	192	192	128	
	40' HQ	set	216	216	216	216	128	

Model			CHV-5SDH100NK	CHV-5SDH112NK	CHV-5SDH125NK	CHV-5SDH140NK	CHV-5SDH160NK	CHV-5SDH224NK	CHV-5SDH280NK	
Capacity	Cooling	kW	10,0	11,2	12,5	14,0	16,00	22,4	28,0	
	Heating	kW	11,2	12,5	14,0	16,0	18,00	25,0	31,0	
Power supply		V/Ph/Hz	220-240/1/50 & 208-230/1/60				220-240/1/50/60	220-240/1/50 & 208-230/1/60		
Power consumption		W	200	200	220	220	560	800	900	
Airflow volume(H/M/L)		m³/h	1700/1450/1100	1700/1450/1100	2000/1550/1200	2000/1700/1400	3100	4000	4400	
		CFM	1000/853/650	1000/853/650	1175/912/706	1175/1000/824	1824	2590	2590	
Rated Current	Cooling	A	1,0	1,0	1,0	1,0	4	4,1	4,6	
	Heating	A	1,0	1,0	1,0	1,0	4	4,1	4,6	
ESP		A	70-100				50	150/50-200	150/50-200	
Sound pressure level (H/M/L)		Pa	46/44/42	46/44/42	48/45/42	48/46/44	55,0	54,0	55,0	
Connecting pipe diameter	Liquid	dB(A)	Φ9,52	Φ9,52	Φ9,52	Φ9,52	Φ9,52	Φ9,52	Φ9,52	
	Gas	mm	Φ15,9	Φ15,9	Φ15,9	Φ15,9	cp19	Φ22,2	Φ22,2	
Drain pipe	External dia.	mm	Φ25	Φ25	Φ25	Φ25	Φ30	Φ30	Φ30	
	Thickness	mm	2,5	2,5	2,5	2,5	1,5	1,5	1,5	
Dimension (WxDxH)	Outline	mm	1229x775x290				1497x799x389	1483x791x385	1686x870x450	
	Package	mm	1338x877x305				1578x883x400	1758x883x470	1788x988x580	
Net weight/Gross weight		mm	47/54	47/54	47/54	47/54	79/103	82/104	105/140	
Loading quantity	40' GP	kg	128	128	128	128	75	65	52	
	40' HQ	set	128	128	128	128	75	65	52	

Low static pressure duct type indoor unit 50/60 Hz

Model			CHV-5SD22NK	CHV-5SD25NK	CHV-5SD28NK	CHV-5SD32NK	CHV-5SD36NK
Capacity	Cooling	kW	2,2	2,5	2,8	3,2	3,6
	Heating	kW	2,5	2,8	3,6	3,6	4,0
Power supply		V/Ph/Hz	220-240/1/50 & 208-230/1/60				
Power consumption		W	35	35	35	43	43
Airflow volume (H/M/L)		m³/h	450/350/250	450/350/250	450/350/250	550/450/350	550/450/350
		CFM	265/206/147	265/206/147	265/206/147	325/265/206	325/265/206
Rated Current	Cooling	A	0,2	0,2	0,2	0,2	0,2
	Heating	A	0,2	0,2	0,2	0,2	0,2
ESP		Pa	15/0-30				
Sound pressure level(H/M/L)		dB(A)	31/28/25	31/28/25	31/28/25	32/30/27	32/30/27
Connecting pipe diameter	Liquid	mm	Φ6,35	Φ6,35	Φ6,35	Φ6,35	Φ6,35
	Gas	mm	Φ9,52	Φ9,52	Φ9,52	Φ12,7	Φ12,7
Drain pipe	External dia.	mm	25	25	25	25	25
	Thickness	mm	2,5	2,5	2,5	2,5	2,5
Dimension (WxDxH)	Outline	mm	700x615x200				
	Package	mm	893x743x305				
Net weight / Gross weight		kg	22/27	22/27	22/27	22/28	22/28
Loading quantity	40' GP	set	192	192	192	192	192
	40' HQ	set	192	192	192	192	192

Model			CHV-5SD40NK	CHV-5SD45NK	CHV-5SD50NK	CHV-5SD56NK	CHV-5SD63NK
Capacity	Cooling	kW	4,0	4,5	5,0	5,6	6,3
	Heating	kW	4,5	5,0	5,6	6,3	7,1
Power supply		V/Ph/Hz	220-240/1/50 & 208-230/1/60				
Power consumption		W	52	52	52	99	99
Airflow volume (H/M/L)		m³/h	700/600/450	700/600/450	700/600/450	1000/800/600	1000/800/600
		CFM	410/355/265	410/355/265	410/355/265	590/471/355	590/471/355
Rated Current	Cooling	A	0,3	0,3	0,3	0,5	0,5
	Heating	A	0,3	0,3	0,3	0,5	0,5
ESP		Pa	15/0-30				
Sound pressure level(H/M/L)		dB(A)	33/31/28	33/31/28	33/31/28	35/33/30	35/33/30
Connecting pipe diameter	Liquid	mm	Φ6,35	Φ6,35	Φ6,35	Φ9,52	Φ9,52
	Gas	mm	Φ12,7	Φ12,7	Φ12,7	Φ15,9	Φ15,9
Drain pipe	External dia.	mm	25	25	25	25	25
	Thickness	mm	2,5	2,5	2,5	2,5	2,5
Dimension (WxDxH)		Outline	900x615x200			1100x615x200	
		Package	1123x743x305			1323x743x305	
Net weight / Gross weight		kg	27/33	27/33	27/33	31/38	31/38
Loading quantity	40' GP	set	192	192	192	162	162
	40' HQ	set	192	192	192	162	162

Model			CHV-5SD71NK	CHV-5SD80NK	CHV-5SD90NK	CHV-5SD100NK	CHV-5SD112NK	CHV-5SD125NK	CHV-5SD140NK
Capacity	Cooling	kW	7,1	8,0	9,0	10,0	11,2	12,5	14,0
	Heating	kW	8,0	9,0	10,0	11,2	12,5	14,0	16,0
Power supply		V/Ph/Hz	220-240/1/50 & 208-230/1/60						
Power consumption		W	105	140	209	209	209	230	230
Airflow volume (H/M/L)		m³/h	1000/800/600	1100/1000/800	1500/1250/950	1500/1350/1000	1700/1500/1100	2000/1500/1150	2000/1500/1150
		CFM	590/471/355	650/590/471	885/736/599	885/795/590	1000/885/650	1175/885/677	1175/885/677
Rated Current	Cooling	A	0,5	0,7	1,0	1,0	1,0	1,1	1,1
	Heating	A	0,5	0,7	1,0	1,0	1,0	1,1	1,1
ESP		Pa	30/0-50						
Sound pressure level(H/M/L)		dB(A)	35/33/30	36/34/31	40/36/32	40/36/32	40/36/32	42/40/37	42/40/37
Connecting pipe diameter	Liquid	mm	Φ9,52	Φ9,52	Φ9,52	Φ9,52	Φ9,52	Φ9,52	Φ9,52
	Gas	mm	Φ15,9	Φ15,9	Φ15,9	Φ15,9	Φ15,9	Φ15,9	Φ15,9
Drain pipe	External dia.	mm	25	25	25	25	25	25	25
	Thickness	mm	2,5	2,5	2,5	2,5	2,5	2,5	2,5
Dimension (WxDxH)		Outline	1200x655x260			1340x655x260			
		Package	1448x858x315			1591x861x330			
Net weight / Gross weight		kg	40/47	40/47	46/55	46/55	46/55	47/56	47/56
Loading quantity	40' GP	set	96	96	78	78	78	78	78
	40' HQ	set	96	96	78	78	78	78	78

Slim Ducted Type Indoor Unit 50/60 Hz

Model			CHV-5SDS22NK*	CHV-5SDS25NK*	CHV-5SDS28NK*	CHV-5SDS32NK*	CHV-5SDS36NK*
Capacity	Cooling	kW	2,2	2,5	2,8	3,2	3,6
	Heating	kW	2,5	2,8	3,2	3,6	4,0
Power supply		V/Ph/Hz	220-240/1/50 & 208-230/1/60				
Power consumption		W	25	25	25	30	30
Airflow volume (H/M/L)		m³/h	450/400/320	450/400/320	450/400/320	550/450/340	550/450/340
		CFM	265/235/188	265/235/188	265/235/188	324/265/200	324/265/200
Rated Current	Cooling	A	0,2	0,2	0,2	0,3	0,3
	Heating	A	0,2	0,2	0,2	0,3	0,3
ESP		Pa	0/15				
Sound pressure level(H/M/L)		dB(A)	30/28/22	30/28/22	30/28/22	31/29/25	31/29/25
Connecting pipe diameter	Liquid	mm	Φ6,35	Φ6,35	Φ6,35	Φ6,35	Φ6,35
	Gas	mm	Φ9,52	Φ9,52	Φ9,52	Φ9,52	Φ12,7
Drain pipe	External dia.	mm	25	25	25	25	25
	Thickness	mm	2,5	2,5	2,5	2,5	2,5
Dimension (WxDxH)		Outline	710x450x200				
		Package	1003x551x285				
Net weight / Gross weight		kg	18,5/22	18,5/22	18,5/22	19,5/23	19,5/23
Loading quantity	40' GP	set	352	352	352	352	352
	40' HQ	set	352	352	352	352	352

Model			CHV-5SDS40NK*	CHV-5SD45NK*	CHV-5SD50NK*	CHV-5SD56NK*	CHV-5SD63NK*	CHV-5SD71NK*	
Capacity	Cooling	kW	4,0	4,5	5,0	5,6	6,3	7,2	
	Heating	kW	4,5	5,0	5,6	6,3	7,0	8,0	
Power supply		V/Ph/Hz	I 220-240/1 /50 & 208-230/1 /60						
Power consumption		W	35	35	35	45	45	50	
Airflow volume (H/M/L)		m³/h	750/660/540	750/660/540	750/660/540	850/700/610	850/700/610	1100/800/640	
		CFM	441/388/318	441/388/318	441/388/318	500/412/359	500/412/359	647/471/377	
Rated Current	Cooling	A	0,3	0,3	0,3	0,3	0,3	0,5	
	Heating	A	0,3	0,3	0,3	0,3	0,3	0,5	
ESP		Pa	0/15						
Sound pressure level(H/M/L)		dB(A)	33/30/27	33/30/27	33/30/27	35/33/29	35/33/29	37/34/30	
Connecting pipe diameter	Liquid	mm	Φ6,35	Φ6,35	Φ6,35	Φ9,52	Φ9,52	Φ9,52	
	Gas	mm	Φ12,7	Φ12,7	Φ12,7	Φ15,9	Φ15,9	Φ15,9	
Drain pipe	External dia.	mm	25	25	25	25	25	25	
	Thickness	mm	2,5	2,5	2,5	2,5	2,5	2,5	
Dimension (WxDxH)	Outline	mm	1010x450x200				1010x450x200	1310x450x200	
	Package	mm	1303x551x285				1303x551x285	1603x551x285	
Net weight / Gross weight		kg	23,5/28	23,5/28	23,5/28	24,5/29	24,5/29	30,5/36	
Loading quantity	40' GP	set	288	288	288	288	288	224	
	40' HQ	set	288	288	288	288	288	224	

Note: * This series is without water pump.

4-way Cassette Indoor unit 50/60 Hz

Model			CHV-5SC28NK	CHV-5SC36NK	CHV-5SC45NK	CHV-5SC50NK	CHV-5SC56NK	CHV-5SC63NK	CHV-5SC71NK	
Capacity	Cooling	kW	2,8	3,6	4,5	5,0	5,6	6,3	7,1	
	Heating	kW	3,2	4,0	5,0	5,6	6,3	7,1	8,0	
Power supply		V/Ph/Hz	220-240/1/50 & 208-230/1/60							
Power consumption		W	48	48	48	50	59	59	68	
Airflow volume (H/M/L)		m³/h	750/650/550	750/650/550	750/650/550	830/650/550	1000/900/750	1000/900/750	1180/950/850	
		CFM	440/383/325	440/383/325	440/383/325	490/383/325	590/530/440	590/530/440	695/559/550	
Rated Current	Cooling	A	0,2	0,2	0,2	0,2	0,3	0,3	0,3	
	Heating	A	0,2	0,2	0,2	0,3	0,3	0,3	0,3	
Sound pressure level(H/M/L)		dB(A)	36/34/31	36/34/31	36/34/31	36/34/31	37/35/32	37/35/32	38/36/33	
Connecting pipe diameter	Liquid	mm	Φ6,35	Φ6,35	Φ6,35	Φ6,35	Φ9,52	Φ9,52	Φ9,52	
	Gas	mm	Φ9,52	Φ12,7	Φ12,7	Φ12,7	Φ15,9	Φ15,9	Φ15,9	
Drain pipe	External dia.	mm	25	25	25	25	25	25	25	
	Thickness	mm	2,5	2,5	2,5	2,5	2,5	2,5	2,5	
Case	Dimension (WxDxH)	Outline	mm	840x840x190	840x840x190	840x840x190	840x840x190	840x840x240	840x840x240	840x840x240
		Package	mm	963x963x272	963x963x272	963x963x272	963x963x272	963x963x325	963x963x325	963x963x325
	Net weight / Gross weight		kg	22,5/29,5	22,5/29,5	22,5/29,5	22,5/29,5	26,5/34,5	26,5/34,5	26,5/34,5
Panel	Dimension (WxDxH)	Outline	mm	950x950x65	950x950x65	950x950x65	950x950x65	950x950x65	950x950x65	950x950x65
		Package	mm	1033x1038x133	1033x1038x133	1033x1038x133	1033x1038x133	1033x1038x133	1033x1038x133	1033x1038x133
	Net weight / Gross weight		kg	7/11	7/11	7/11	7/11	7/11	7/11	7/11
Loading quantity	40' GP	set	167	167	167	167	140	140	140	
	40' HQ	set	171	171	171	171	156	156	156	

Model			CHV-5SC80NK	CHV-5SC90NK	CHV-5SC100NK	CHV-5SC112NK	CHV-5SC125NK	CHV-5SC140NK	CHV-5SC160NK	
Capacity	Cooling	kW	8,0	9,0	10,0	11,2	12,5	14,0	16,0	
	Heating	kW	9,0	10,0	11,2	12,5	14,0	16,0	17,5	
Power supply		V/Ph/Hz	220-240/1/50 & 208-230/1/60							
Power consumption		W	68	98	98	110	110	110	130	
Airflow volume (H/M/L)		m³/h	1180/950/850	1500/1350/1100	1500/1350/1100	1700/1400/1100	1860/1500/1150	1860/1500/1150	2100/1700/1400	
		CFM	695/559/550	880/795/650	880/795/650	1000/824/650	1095/880/677	1095/880/677	1235/1000/824	
Rated Current	Cooling	A	0,3	0,4	0,4	0,5	0,5	0,5	0,6	
	Heating	A	0,3	0,4	0,4	0,5	0,5	0,5	0,6	
Sound pressure level(H/M/L)		dB(A)	38/36/33	40/37/35	40/37/35	41/38/36	43/41/38	43/41/38	47/44/42	
Connecting pipe diameter	Liquid	mm	Φ9,52	Φ9,52	Φ9,52	Φ9,52	Φ9,52	Φ9,52	Φ9,52	
	Gas	mm	Φ15,9	Φ15,9	Φ15,9	Φ15,9	Φ15,9	Φ15,9	Φ19,05	
Drain pipe	External dia.	mm	25	25	25	25	25	25	25	
	Thickness	mm	2,5	2,5	2,5	2,5	2,5	2,5	2,5	
Case	Dimension (WxDxH)	Outline	mm	840x840x240	840x840x320	840x840x320	840x840x320	840x840x320	840x840x320	910x910x293
		Package	mm	963x963x325	963x963x409	963x963x409	963x963x409	963x963x409	963x963x409	1023x993x375
	Net weight / Gross weight		kg	26,5/34,5	32,5/40,0	32,5/40,0	32,5/40,0	32,5/40,0	32,5/40,0	46,5/56,5
Panel	Dimension (WxDxH)	Outline	mm	950x950x65	950x950x65	950x950x65	950x950x65	950x950x65	950x950x65	1040x1040x65
		Package	mm	1033x1038x133	1033x1038x133	1033x1038x133	1033x1038x133	1033x1038x133	1033x1038x133	1137x1137x140
	Net weight / Gross weight		kg	7/11	7/11	7/11	7/11	7/11	7/11	7,5/11,5
Loading quantity	40' GP	set	140	104	104	104	104	104	144	
	40' HQ	set	156	119	119	119	119	119	144	

1-way Cassette Indoor Unit 50/60 Hz

Model			CHV-5SCW22NK	CHV-5SCW28NK	CHV-5SCW36NK	CHV-5SCW45NK	CHV-5SCW50NK
Capacity	Cooling	kW	2,2	2,8	3,6	4,5	5,0
	Heating	kW	2,5	3,2	4,0	5,0	5,6
Power supply		V/Ph/Hz	220-240/1/50 & 208-230/1/60				
Power consumption		W	30	30	30	45	45
Airflow volume (H/M/L)		m³/h	600/500/450	600/500/450	600/500/450	830/600/500	830/600/500
		CFM	355/295/265	355/295/265	355/295/265	490/355/295	490/355/295
Rated Current	Cooling	A	0,2	0,2	0,2	0,3	0,3
	Heating	A	0,2	0,2	0,2	0,3	0,3
Sound pressure level(H/M/L)		dB(A)	36/32/28	36/32/28	36/32/28	40/35/30	40/35/30
Connecting pipe diameter	Liquid	mm	Φ6,35	Φ6,35	Φ6,35	Φ6,35	Φ6,35
	Gas	mm	Φ9,52	Φ12,7	Φ12,7	Φ12,7	Φ12,7
Drain pipe	External dia.	mm	25	25	25	25	25
	Thickness	mm	2,5	2,5	2,5	2,5	2,5
Case	Dimension (WxDxH)	Без упаковки	mm	987x385x178	987x385x178	987x385x178	987x385x178
		В упаковке	mm	1307x501x310	1307x501x310	1307x501x310	1307x501x310
	Net weight / Gross weight		kg	20,0/27,0	20,0/27,0	20,0/27,0	21,0/28,5
Panel	Dimension (WxDxH)	Outline	mm	1200x460x55	1200x460x55	1200x460x55	1200x460x55
		Package	mm	1265x536x118	1265x536x118	1265x536x118	1265x536x118
	Net weight / Gross weight		kg	4,2/6,0	4,2/6,0	4,2/6,0	4,2/6,0
Loading quantity	40' GP	set	138	138	138	138	138
	40' HQ	set	138	138	138	138	138

Wall-mounted Type Indoor Unit 50/60 Hz

Model			CHV-5SW22NK*	CHV-5SW28NK*	CHV-5SW36NK*	CHV-5SW45NK*	CHV-5SW50NK*	CHV-5SW56NK*	CHV-5SW63NK*	CHV-5SW71NK*	
Capacity	Cooling	kW	2,2	2,8	3,6	4,5	5,0	5,6	6,3	7,1	
	Heating	kW	2,5	3,2	4,0	5,0	5,8	6,3	7,0	7,5	
Power supply		V/Ph/Hz	220-240/1/50								
Power consumption		W	50	50	60	60	60	70	70	70	
Airflow volume (H/M/L)		m³/h	500/420/350	500/420/350	630/550/480	630/550/480	630/550/480	750/600/500	750/600/500	750/600/500	
		CFM	294/247/206	294/247/206	371/324/282	371/324/282	371/324/282	441/353/294	441/353/294	441/353/294	
Rated Current	Cooling	A	0,2	0,2	0,31	0,31	0,31	0,31	0,31	0,31	
	Heating	A	0,2	0,2	0,31	0,31	0,31	0,31	0,31	0,31	
Sound pressure level(H/M/L)		dB(A)	38/34/30	38/34/30	44/41/38	44/41/38	44/41/38	44/41/38	44/41/38	44/41/38	
Connecting pipe diameter	Liquid	mm	Φ6,35	Φ6,35	Φ6,35	Φ6,35	Φ6,35	Φ9,52	Φ9,52	Φ9,52	
	Gas	mm	Φ9,52	Φ9,52	Φ12,7	Φ12,7	Φ12,7	Φ15,9	Φ15,9	Φ15,9	
Drain pipe	External dia.	mm	Φ20	Φ20	Φ20	Φ20	Φ20	Φ30	Φ30	Φ30	
	Thickness	mm	1,5	1,5	1,5	1,5	1,5	1,5	1,5	1,5	
Dimension (WxDxH)	Outline	mm	843x180x275			940x200x298			1008x221x319		
	Package	mm	973x258x370			1068x288x395			1131x398x328		
Net weight / Gross weight		kg	10/12,5	10/12,5	12,5/15,5	12,5/15,5	12,5/15,5	15/18,5	15/18,5	15/18,5	
Loading quantity	40' GP	set	702	702	557	557	557	441	441	441	
	40' HQ	set	819	819	624	624	624	503	503	503	

Concealed Floor Standing Type 50/60 Hz

Model			CHV-5SF28NK	CHV-5SF36NK	CHV-5SF50NK	CHV-5SF63NK	CHV-5SF71NK	CHV-5SF90NK	CHV-5SF112NK	CHV-5SF125NK	CHV-5SF140NK
Capacity	Cooling	kW	2,8	3,6	5,0	6,3	7,1	9,0	11,2	12,5	14,0
	Heating	kW	3,2	4,0	5,6	7,1	8,0	10,0	12,5	14,0	16,0
Power supply		V/Ph/Hz	220-240/1/50 & 208-230/1/60								
Power consumption		W	40	40	50	75	75	140	160	160	160
Airflow volume (H/M/L)		m³/h	650/580/500/650/580/500	650/580/500	950/850/700	1400/1150/1000	1400/1150/1000	1600/1400/1200	2000/1800/1450	2000/1800/1450	2000/1800/1450
		CFM	380/341/294	380/341/294	560/500/410	825/677/590	825/677/590	940/824/706	1175/1059/853	1175/1059/853	1175/1059/853
Rated Current	Cooling	A	0,2	0,2	0,25	0,38	0,38	0,7	0,95	0,95	0,95
	Heating	A	0,2	0,2	0,25	0,38	0,38	0,7	0,95	0,95	0,95
Sound pressure level(H/M/L)		dB(A)	36/34/32	36/34/32	42/38/33	44/42/39	44/42/39	50/47/43	51/47/42	52/49/45	52/49/45
Connecting pipe diameter	Liquid	mm	Φ6,35	Φ6,35	Φ6,35	Φ9,52	Φ9,52	Φ9,52	Φ9,52	Φ9,52	Φ9,52
	Gas	mm	Φ9,52	Φ12,7	Φ12,7	Φ15,9	Φ15,9	Φ15,9	Φ15,9	Φ15,9	Φ15,9
Drain pipe	External dia.	mm	Φ17	Φ17	Φ17	Φ17	Φ17	Φ17	Φ17	Φ17	Φ17
	Thickness	mm	1,75	1,75	1,75	1,75	1,75	1,75	1,75	1,75	1,75
Dimension (WxDxH)	Outline	mm	1220x700x225			1420x700x245			1700x700x245		
	Package	mm	1343x823x315			1548x828x345			1828x828x345		
Net weight / Gross weight		kg	40/49	40/49	40/49	50/58	50/58	50/58	60/68	60/68	60/68
Loading quantity	40' GP	set	145	145	145	90	90	90	84	84	84
	40' HQ	set	158	158	158	98	98	98	98	98	98

Console Indoor Unit 50/60 Hz

Model			CHV-5SK22NK	CHV-5SK28NK	CHV-5SK36NK	CHV-5SK45NK	CHV-5SK50NK
Capacity	Cooling	kW	2,2	2,8	3,6	4,5	5,0
	Heating	kW	2,5	3,2	4,0	5,0	5,5
Power supply		V/Ph/Hz	220-240/1/50 & 208-230/1/60				
Power consumption		W	15	15	20	40	40
Airflow volume (H/M/L)		m³/h	400/320/270	400/320/270	480/400/310	680/600/500	680/600/500
		CFM	235/188/159	235/188/159	282/235/182	400/353/294	400/353/294
Rated Current	Cooling	A	0,15	0,15	0,15	0,15	0,15
	Heating	A	0,15	0,15	0,15	0,15	0,15
Airflow volume (H/M/L)		dB(A)	38/33/27	38/33/27	40/37/32	46/43/39	46/43/39
Connecting pipe diameter	Liquid	mm	6,35	6,35	6,35	6,35	6,35
	Gas	mm	9,52	9,52	9,52	12,7	12,7
Drain pipe	External dia.	mm	17,2	17,2	17,2	17,2	17,2
	Thickness	mm	1	1	1	1	1
Dimension (WxDxH)	Outline	mm	700/215/600	700/215/600	700/215/600	700/215/600	700/215/600
	Package	mm	780x285x682	780x285x682	780x285x682	780x285x682	780x285x682
Net weight / Gross weight		kg	16/19	16/19	16/19	16/19	16/19
Loading quantity	40' GP	set	387	387	387	387	387
	40' HQ	set	433	433	433	433	433

Fresh Air Processing Indoor Unit 50/60 Hz

Model			CHV-5SA140N(X1.2)K*	CHV-5SA224N(X2.0)M *	CHV-5SA280N(X2.5)M *	CHV-5SA280N(X3.0)M *	CHV-5SA450N(X4.0)M *
Capacity	Cooling	kW	14,0	22,4	28,0	28,0	45,0
	Heating	kW	10,0	16,0	20,0	20,0	32,0
Power supply		V/Ph/Hz	220-240/1/50		380-415/3/50		
Power consumption		W	360	740	760	1060	1240
Airflow volume (H/M/L)		m³/h	1200	2000	2500	3000	4000
		CFM	705	1175	1470	1765	2355
Rated Current	Cooling	A	1,82	1,32	1,36	1,89	2,22
	Heating	A	1,82	1,32	1,36	1,89	2,22
ESP		Pa	150		200		
Airflow volume (H/M/L)		dB(A)	42	47	48	51	52
Connecting pipe diameter	Liquid	mm	Φ9,52	Φ9,52	Φ9,52	Φ9,52	Φ12,7
	Gas	mm	Φ15,9	Φ19,05	Φ22,2	Φ22,2	Φ28,6
Drain pipe	External dia.	mm	25	25	25	25	25
	Thickness	mm	2,5	2,5	2,5	2,5	2,5
Dimension (WxDxH)	Outline	mm	1463x756x300	1500x 1000x500			1700x 1100x650
	Package	mm	1514x785x360	1840x1200x673			1890x1460x835
Net weight / Gross weight		kg	63,5/71	130/182	134/188	134/188	208/266
Loading quantity	40' GP	set	84,0	18,0	18,0	18,0	16,0
	40' HQ	set	98,0	18,0	18,0	18,0	16,0

Note* : This series can be matched with CHV5 (Top discharge outdoor unit)

Tower type unit 50/60 Hz

Model			CHV-5SFS100NK	CHV-5SFS140NK
Capacity	Cooling	kW	10	14
	Heating	kW	11	15
Power supply		V/Ph/Hz	220-240/1 /50 & 208-230/1 /60	
Power consumption		W	185	185
Airflow volume (H/M/L)		m ³ /h	1850/1600/1400	1850/1600/1400
		CFM	1089/942/824	1089/942/824
Rated Current	Cooling	A	1,5	1,5
	Heating	A	1,5	1,5
Airflow volume (H/M/L)		dB(A)	50/48/46	50/48/46
Connecting pipe diameter	Liquid	mm	9	9
	Gas	mm	16	16
Drain pipe	External dia.	mm	31	31
	Thickness	mm	4,5	4,5
Dimension (WxDxH)	Outline	mm	1870x580x400	
	Package	mm	2083/738/545	
Net weight / Gross weight		kg	54/74	57/77
Loading quantity	40' GP	set	67	67
	40' HQ	set	67	67

Control system



VRF selector ultimate

Model selection system is a necessary tool for the sales of VRF system in overseas market. In order to meet the demand of overseas market for model selection system, improve the competitive strength of C&H products in overseas market, C&H provides clients with intelligent, fast and multivariate model selection system.

Intelligent Model Selection

- 1) The system will take multiple aspects into consideration to provide clients with the optimal plan by combining performance, noise, comfort, reliability, cost, etc.
The software can provide user with audio-visual model building experience via visible modeling method. Through the intelligent fast connection, multiple parts of VRF can be correctly and fast linked, which can greatly improve the modeling efficiency of user.
- 2) It can calculate according to user demand, ambient temperature, using location, static pressure, etc. to recommend the suitable IDU, ODU and pipe arrangement. It will check by combining the collocation rate, pipe arrangement, etc. of the whole system, and automatically adjust the unit model to get the optimal model selection plan.
- 3) Using habit and using standard differs in different regions. The intelligent model selection system will conduct special process according to metric/inch system, unit parameters, different language system in different regions.
- 4) It will conduct automatic checking for the whole system, if anyone of the conditions cannot satisfy the user demand, the software will automatically calculate to find the suitable unit and pipe arrangement.



Fast Model Selection

The software can provide user with audio-visual model building experience via visible modeling method. Through the intelligent fast connection, multiple parts of VRF can be correctly and fast linked, which can greatly improve the modeling efficiency of user.

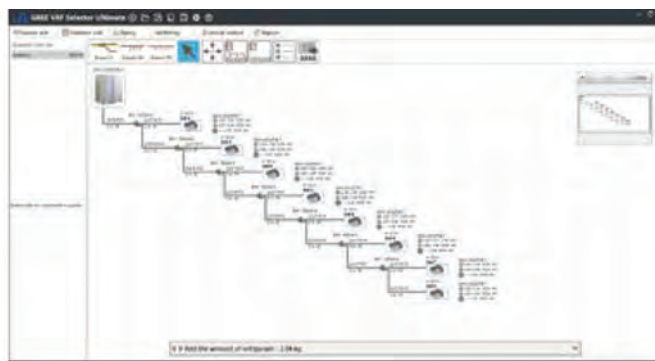

Intelligent debugging software

CHV 5 offers an intelligent debugging software to the end-users for faster construction needs.

Monitoring functions

- Fully control the operation status of each device of the system.
- Hover the mouse over the parameter to display its remarks.
- The online devices will be displayed in a tree structure.
- Display the information of air conditioner in divided regions.
- Each display region can be moved or concealed.
- Display updated status of units in real time.

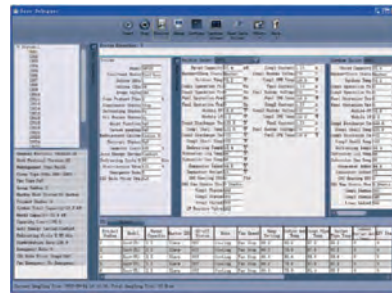

Control functions

- Control the operation of unit as you like.
- Comprehensive control of outdoor unit, indoor unit, water tank, hydro box, etc.
- Real-time display of current status or status after being controlled.
- Both single control and group control are available.

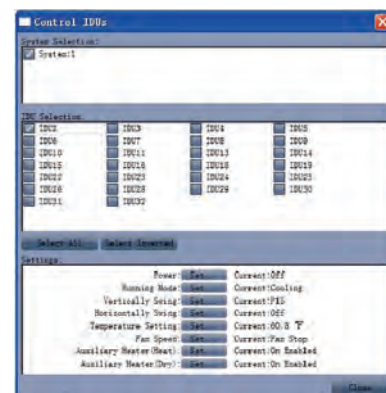

Project debugging functions

- One-click and automatic project debugging.
- Project debugging is arranged step by step from left to right.
- Manual intervention and skipping of some debugging phases are available.
- Green icons will be displayed for the items finishing debugging; red icons will be displayed for the items having debug exception; light yellow icons display debugging information;

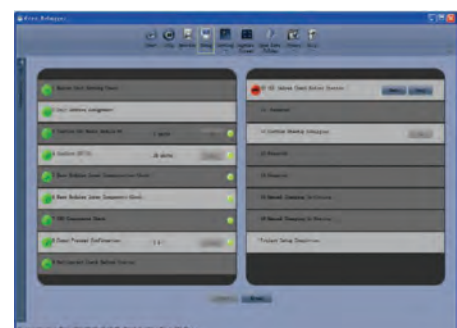

Auto data-saving function

Data will be saved automatically. Database saving path can be changed or data document can be generated repeatedly.

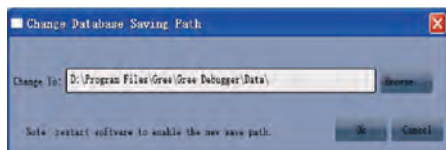

Step 1:
change
database
saving
path

Step 2:
database
save
setting

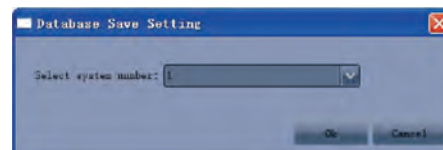

USB data converter

Users can use USB data converter to freely convert CAN/HBS/RS485 data into USB data, achieving data interchange between computer and air conditioner.

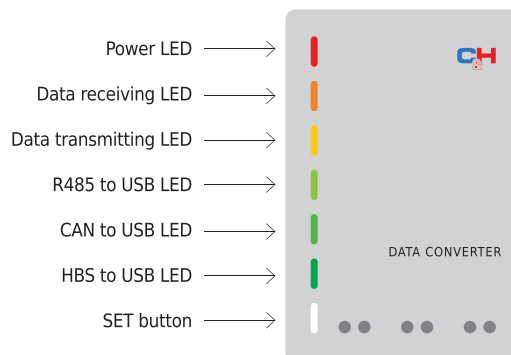

Auto direction of connection way

The wiring diagram will direct connection way automatically, so that the user can get the connection way quickly.

Single System Network

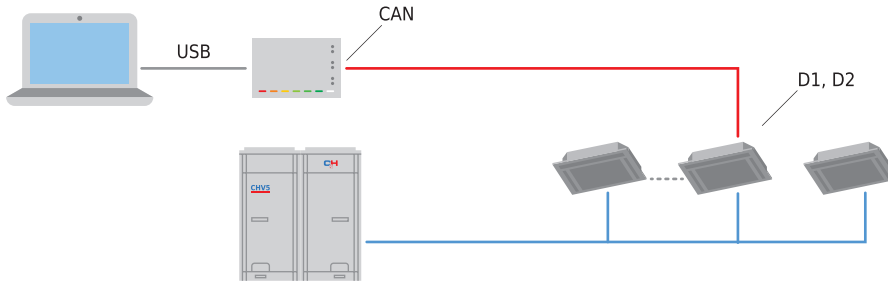

Single System Network

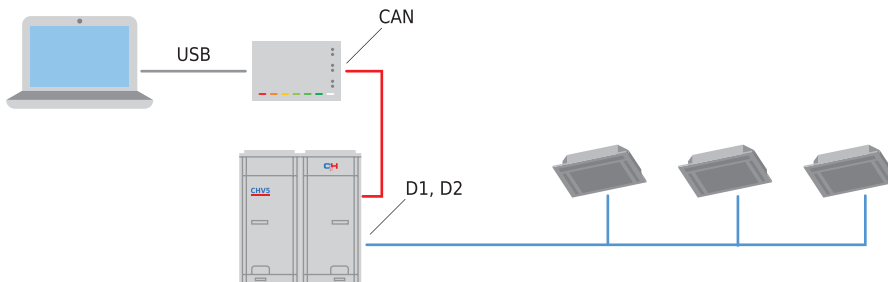

Multi System Network

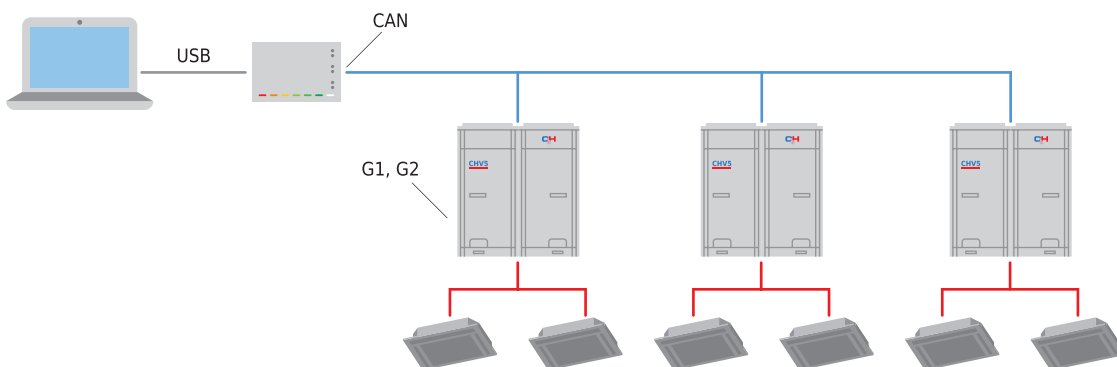

CHV WI-FI module makes possible to control CHV indoor units via wireless connection. Module connected to communication line by means of Wi-Fi router with the cable.

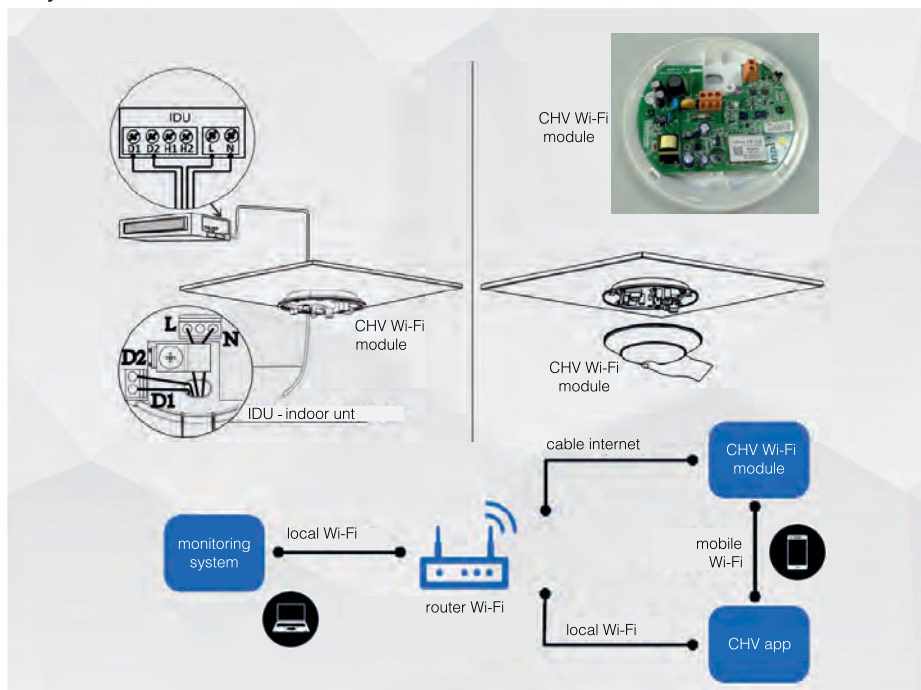

Specific module and software, are included to intelligent system which is calculating the energy losses for cooling and heating for every of indoor unit. In one system it is possible to incorporate up to 256 indoor and up to 16 outdoor units.

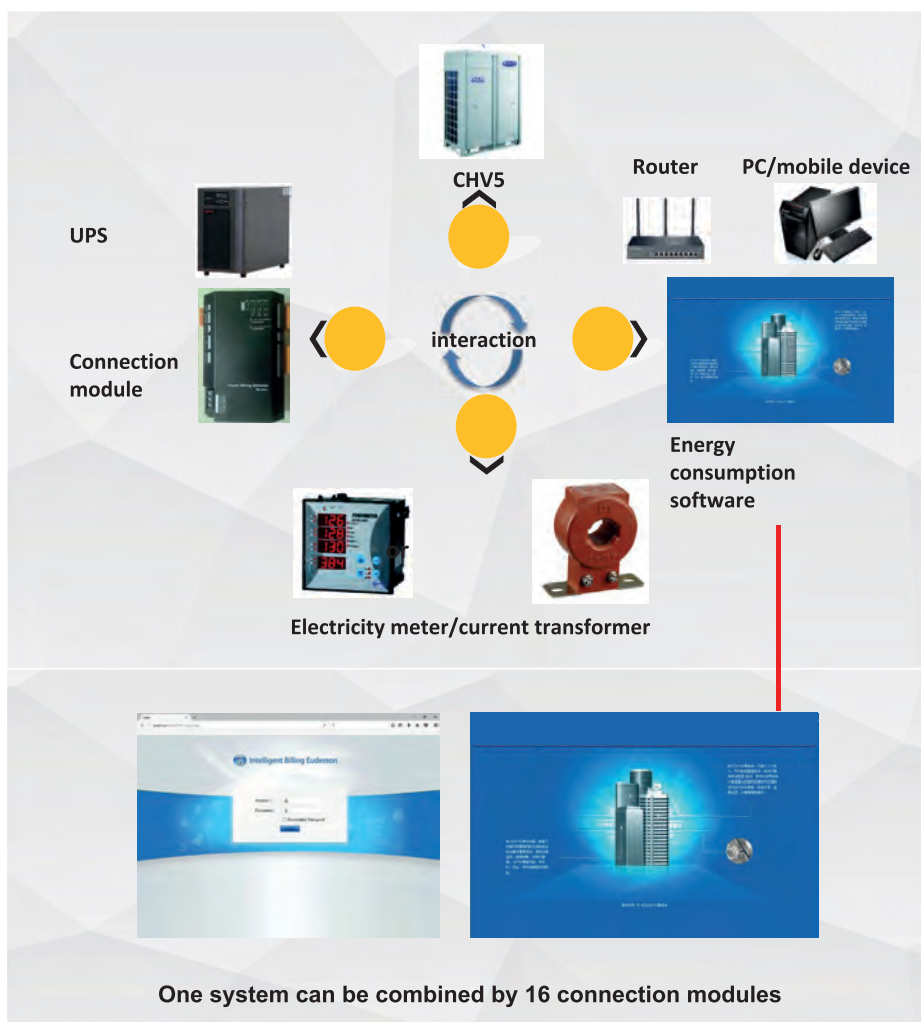

Intelligent system of parallel remote control

For maximizing of satisfying CHV5 user's requirements, Company C&H present new intelligent system of remote parallel control. The system can simultaneously control one room as well as whole building.

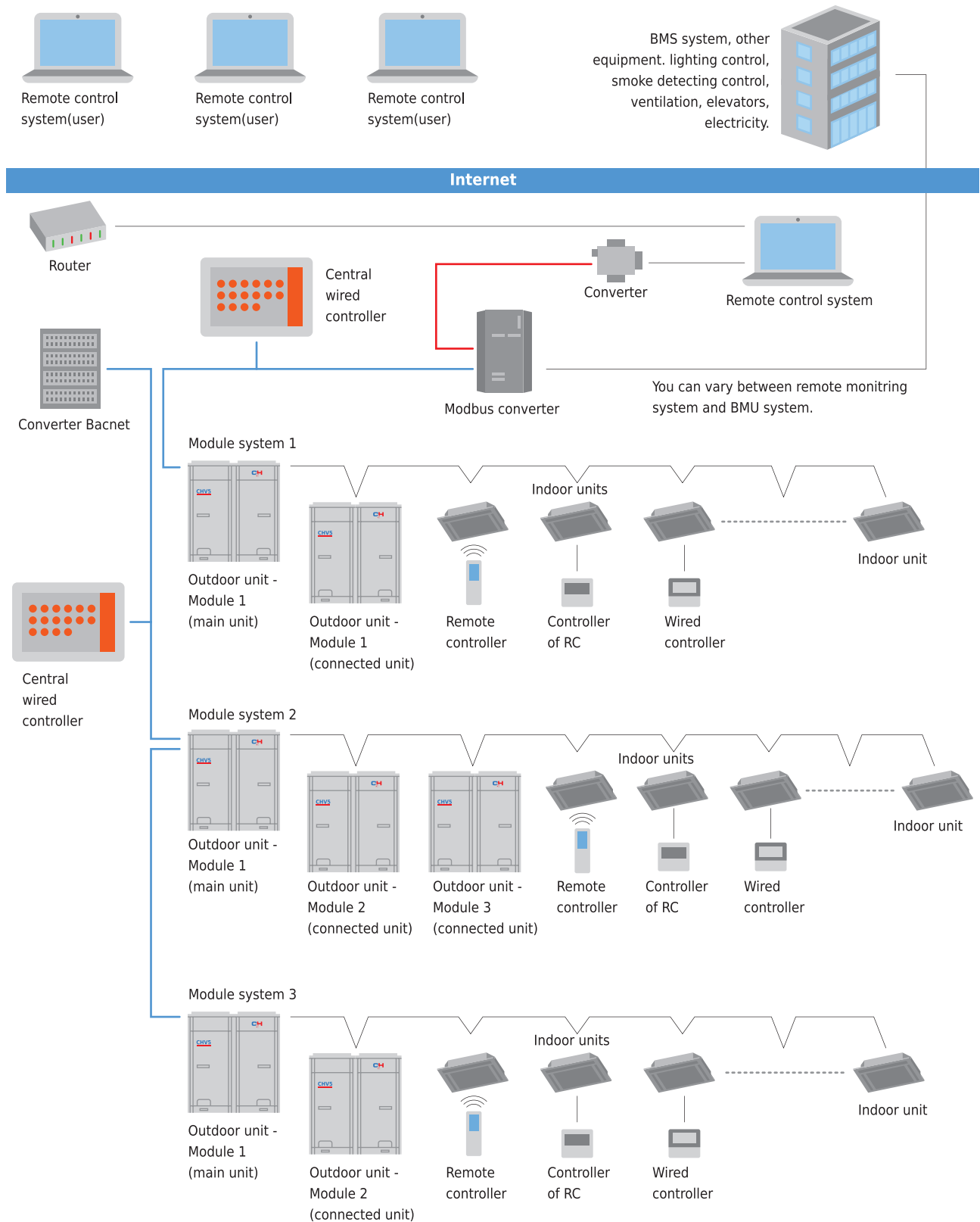

Visualizing

- SCADA soft has graphic part of the model unit. It also can displays the picture of the air conditioner in every room in whole building.
- System can detect the status and quantity of air conditioners on different levels of the building.



Daily control

➤ Set daily timing

- A. Control for period of day/week/month/year;
- B. Every unit control;
- C. Simple display control.

➤ Daily control in various modes

- A. Overtime operation control;
- B. Lunchtime operation control;
- C. Work time operation control.

➤ Other functions

- A. On/Off PWR Supply, modes, humidity, fan speed;
- B. You can reduce energy consumption, when user forget to turn off an air conditioner.

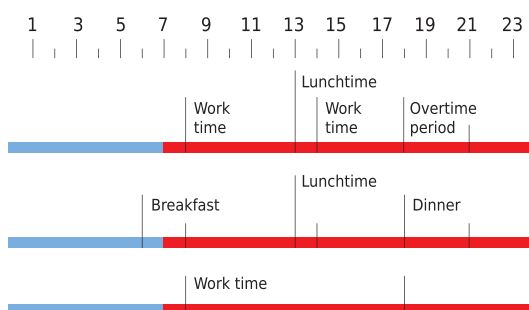

Multi-control

➤ Central control of several units

- A. Easy select of groups;
- B. Central controller to ON/OFF functions
- C. Central controller to temperature operate
- D. Central controller to switch modes;
- E. Central controller to user access.



Access control

➤ Indoor units only

- A. Limited control of ON/OFF;
- B. Limited temperature control;
- C. Limited control of modes.

Analysis of statistics

➤ Statistical data recording

The system can independently perform the graphs based on statistical data for simplifying the analysis and control of the unit.

➤ Faults recording

The system can indicate the information on faults like an outline and forward signals to e-mail.

➤ Recording the operation

The system can trace the records of daily results of user's operation.

Calculation of cost price of energy consumption price

The system calculate automatically in accordance with user's data

- A. It calculates the cost price, energy consumption price, for users in consideration of operation period, modes, refrigerant flow, humidity etc, by separate groups of premiseses.
- B. It has two possible displaying the detail information on calculation of cost price and price calculation in different operation mode.

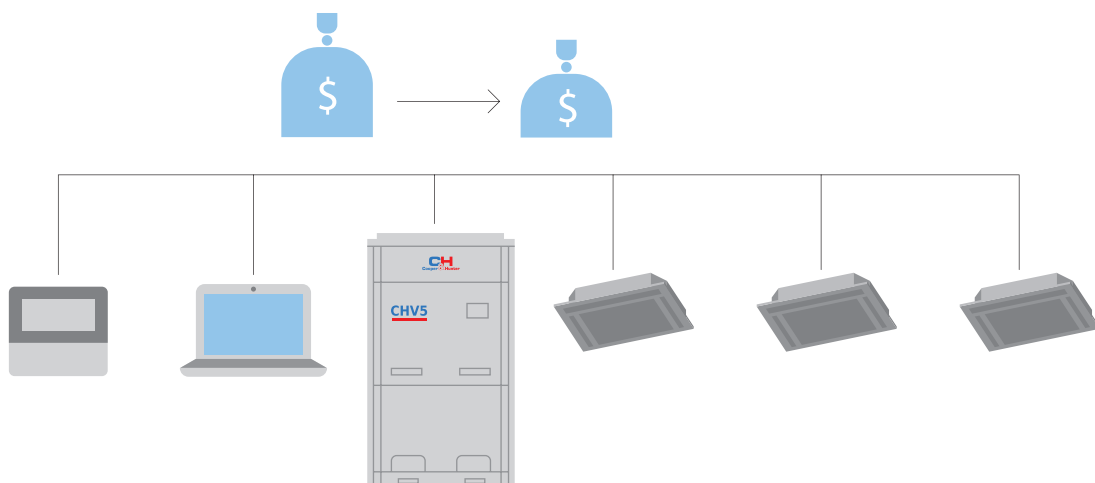

Calculation cost energy consumption

➤ Cost energy analysis

- A. Air conditioners with high level power consumption;
- B. Air conditioners configured on low temperature mode;
- C. Air conditioners with weak cooling capacity.

➤ How to save the energy more:

- A. Operation period;
- B. The unit turned on is too early;
- C. The unit turned off is too lately;
- D. Comfort;
- E. Power consumption price/price per one square meter.

Power consumption energy saving

➤ Energy consumption limitation

- A. Cost energy consumption analysis;
- B. Set the maximum price per kW electricity and unit will reoriented to limited mode with maximum effect;
- C. The system has feature to remind the user of cost electricity during the operation, and makes proposal to save the energy.

➤ Energy saving mode

The system can operate in energy saving mode

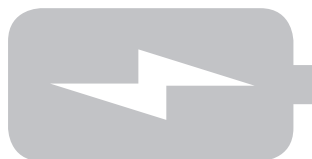

The operation of the unit with demand of VIP users

The system can provide autonomous and unique operation mode with VIP users requirements.





Wired controller and remote controller

There are two kinds of controllers: wired controller and remote controller. The system provides various controls for users, such as cooling, heating, dehumidifying and fan etc., users can select it flexibly according to their own using methods.

Wired controller XK46



- LCD with black background and white words; touch buttons;
- Clock can be displayed and set; 24 hours timer setting for on/off;
- 7 levels of fan speed, up & down swing and left & right swing;
- Can be switched in auto, cooling, dehumidifying, fan, heating, floor heating, 3D heating and space heating operation modes;
- Master and slave wired controllers can be set; simultaneous control over several IDUs is available;
- Available functions: sleep, ventilation, quiet/auto quiet, light, energy saving, auxiliary heating, drying, memory, low-temperature dehumidifying, absence in heating, controllable auxiliary heating in dehumidifying, filter cleaning reminder, etc.;
- Detect ambient temperature; receive infrared remote controller signal;
- With project parameters viewing and setting functions.

Wired controller XK79 (for hotel)



- Small and fashionable appearance with thickness only of 12mm and back lighting LCD with black background and white words;
- Eight touch buttons;
- Clock can be displayed and set in countdown and clock timer;
- Besides normal functions, other functions such as low-temperature dehumidifying, absence in heating, controllable auxiliary heating in dehumidifying and filter cleaning reminder can also be set;
- Door control system can be connected.

Remote controller YAP1F

- Can be switched in auto, cooling, dehumidifying, fan and heating operation modes;
- Besides turbo, 6 levels of fan speed can be set;
- Available functions: child lock, drying, health, ventilation, turbo, sleep, light, absence, I-feel and timer;
- Clock display and indoor/outdoor ambient temperature viewing functions;
- Up & down swing and left & right swing.



Remote controller YV1L1

- Back lighting LCD;
- Can be switched in auto, cooling, dehumidifying, fan, heating, floor heating, 3D heating and space heating operation modes;
- 7 levels of fan speed, up & down swing and left & right swing;
- Available functions: child lock, energy saving, drying, health, ventilation, quiet/auto quiet, sleep, light, absence, low-temperature dehumidifying, I-feel and timer;
- With clock display, system parameters viewing and setting functions.



Wired controller XK55

- Elegant appearance;
- High-resolution color LCD;
- Various timing functions: three weekly timers and one countdown timer can be set simultaneously; mode, temperature and fan speed can be preset in weekly timer;
- Complete system functions; each function will be implemented in an individual page with interactive and humanized interface;
- Various personalized functions, e.g. setting brightness and backlight time;
- Sufficient viewing functions, e.g. viewing on/off status and after-sales service hot line.



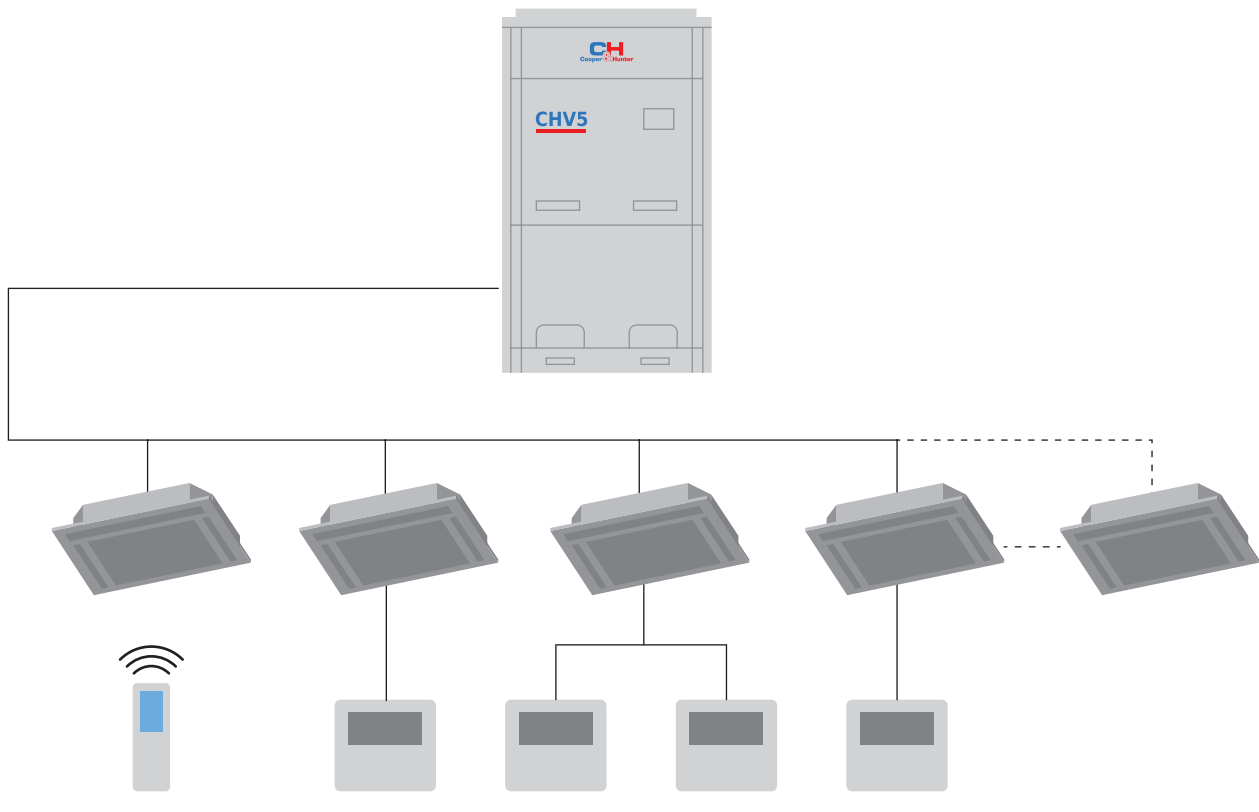

➤ **Joint control of remote controller and wired controller**
Users can control one unit with two types of controllers: a remote controller which is convenient and flexible; or a wired controller which includes every function of an air conditioner.

➤ **Central control of several indoor units**
One wired controller can control as many as 16 indoor units

➤ **Multiple control of one unit**
One indoor unit can be controlled by several wired controllers at different places.

➤ **Single control of one unit**
Each indoor unit has an independent controller.



Smart zone controller and central controller

Smart zone controller CE53-24/F(C)



- High-resolution color LCD;
- E7" capacitive touch screen for easy operation;
- Shielding function of single unit, group and all IDUs (shielding on/off, mode, temp setting, etc.);
- With various functions: centralized control (control all indoor units), group management (support DIY grouping), schedule management (setting of several schedules) and single unit control (on/off, mode, temp setting, fan speed, quiet, swing control, etc.);
- Provide naming of indoor units, selection of icons and personalized settings (setting background, backlight, etc);
- Up to 32 units can be centrally controlled;
- Elegant and fashionable appearance;
- Embedded installation in wall with projecting thickness only of 11mm;
- Connectable with network of indoor units or outdoor units;
- Independent power supply in 100~240V wide voltage range;
- With projectsetting, parameter viewing, malfunction record and access management functions.

Central controller CE52-24/F(C)



- High-resolution color LCD;
- 7" capacitive touch screen for easy operation;
- With project setting, parameter viewing, malfunction record and access management functions.
- With various functions: centralized control (control all indoor units), group management (support DIY grouping), schedule management (setting of several schedules) and single unit control(on/off, mode, temp setting, fan speed, quiet, swing control, etc.);
- Shielding function of single unit, group and all IDUs (shielding on/off, mode, temp setting, etc.);
- Provide naming of indoor units, selection of icons and personalized settings (setting background, backlight, etc);
- Up to 255 units can be centrally controlled;
- Elegant and fashionable appearance;
- Embedded installation in wall with projecting thickness only of 11mm;
- Connectable with network of indoor units or outdoor units;
- Independent power supply in 100~240V wide voltage range;

Converter bacnet

Converter set MG30-24/D2(B) intended for data exchange between AC unit and broadband access server(BAS), to provide standard BACnet/IP interface and 8 interface input/output, one among of them is a signal from fire alarm system. The status of another (7 interface), input/output charted on a special parts of bus BACnet/IP and can be identify by user.

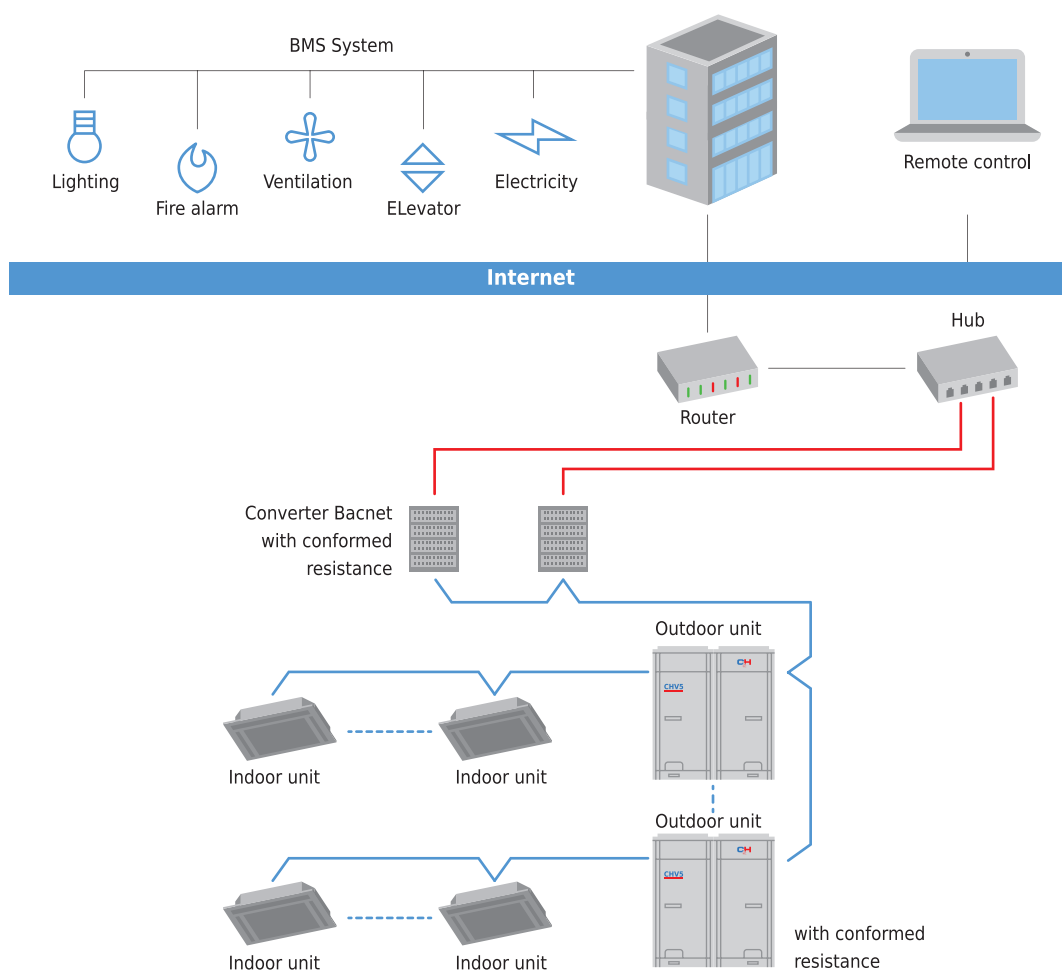
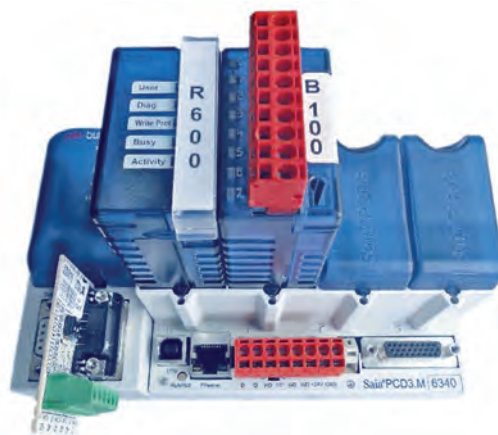

- Interface BACnet/IP, certified by international requirements such as BTL certificate.
- The system of operation status monitoring of the unit in real time, e.g, ON/OFF, modes, temperature.
- Real-time response for control the unit (ON/OFF, operation modes fan speed etc.)by the monitoring of the system.
- Unit fault monitoring.
- Synchronizer operation status, control of all control functions of the block itself or a specific setting function.
- Getting the temperature limitation function of heating and cooling.
- 8 users interfaces input/output of the data from signal of the system and logic outline defining the user.
- Memorization of current data on the operating parameters of the unit for a period of up to 6 months.

Modbus protocol



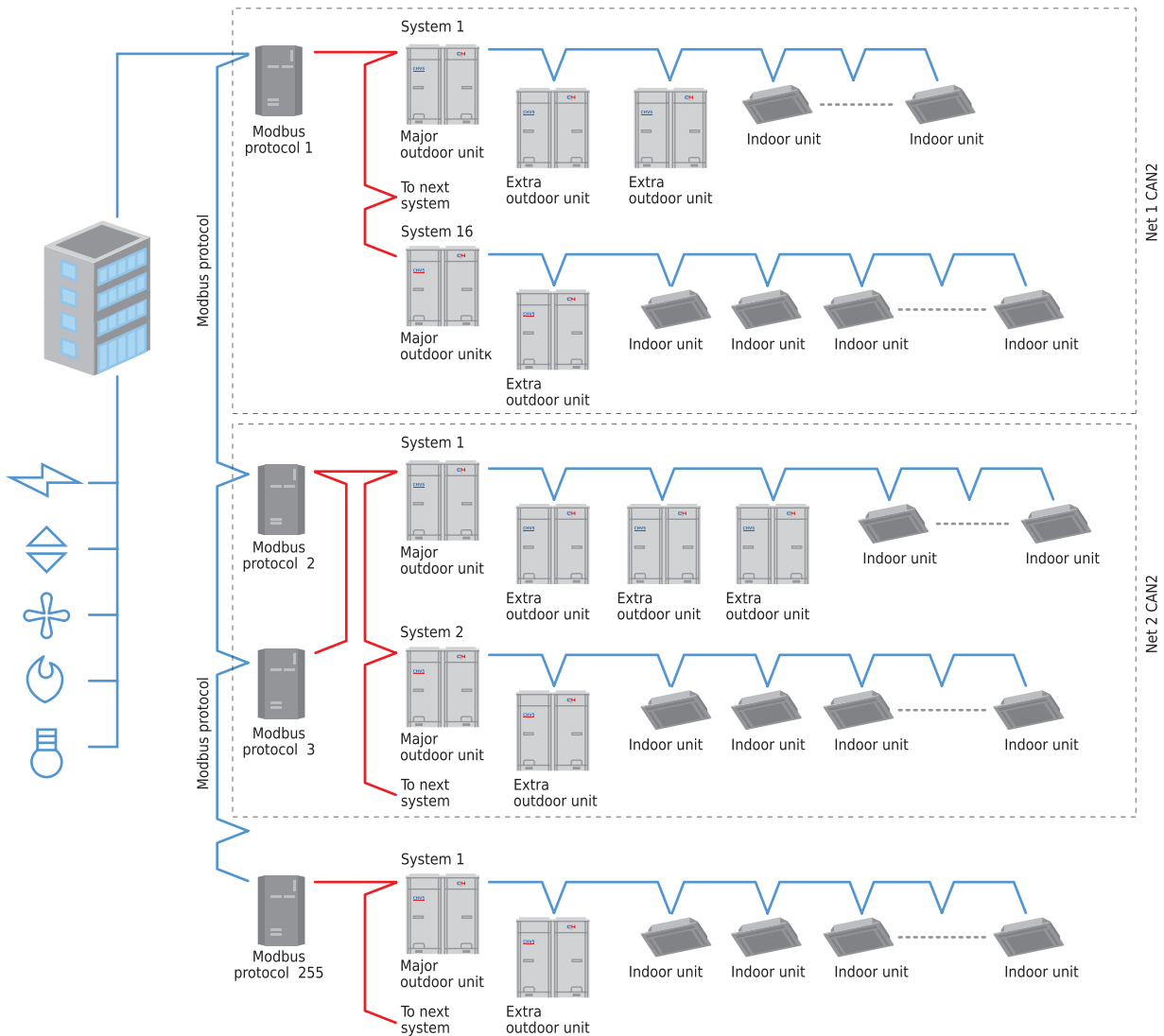









Modbus protocol applied in CHV5 system for integration to building management system (BMS), with aim of receiving central and remote control CHV5 system with functionality of BMS features.



- Real-time response for control the unit (ON/OFF, operation modes fan speed etc.) by the monitoring of the system.
- Switch control for all modes ON/OFF for any unit.
- Unit fault monitoring.
- One Modbus module can support up to 255 gates. One gate Modbus can support up to 16 outdoor units (up to 64 module outdoor units) and 128 indoor units.
- Synchronizer operation status, control of all control functions of the block itself or a specific setting function.
- Connection control, supported 5 DI /5 DO, control possibility by signal from fire alarm system and logic outline of finding the user.
- Comm ports CAN, RS485 are non-polar, and simple for the wiring.
- Getting the temperature limitation function of heating and cooling.
- Wide range voltage 100-240 V ,50/60 Hz, can be implemented for any country.



Control system lineup

Control system		Product series	Cassette type	(High external static pressure, low external static pressure, ducted slim) ducted	Fresh air	Wall-mounted type	Floor-ceiling type	Console type	Floor type	Aur handling
Remote controller	YAP1F		●	○	○	●	●	●	●	○
	YV1L1		○	○	○	○	○	○	○	○
Wired controller	XK46		○	●	●	○	○	○	○	●
	XK79		○	○	○	○	○	○	○	○
	XK55		○	○	○	○	○	○	○	○
	JS05 (ресивер)			○	○					
Central zone controller	CE52-24/F(C)		○	○	○	○	○	○	○	○
Central zone controller	CE53-24/F(C)		○	○	○	○	○	○	○	○
Remote software for monitoring	FE31-00/ AD(BM)		○	○	○	○	○	○	○	○
Auxillary equipment BMS	Connection module (modbus) BACnet bus (BACnet)	ME30-24/ E4(M)		○	○	○	○	○	○	○
		MG30-24/ D2(B)		○	○	○	○	○	○	○
Other devices	Opto-electronic insulated converter	RS232- RS422\485		○	○	○	○	○	○	○
	Opto-electronic insulated signal amplifier	RS- 422\485		○	○	○	○	○	○	○

● — standard equipment

○ — auxillary equipment.



Note

A series of horizontal dotted lines for writing notes.



WWW.COOPERANDHUNTER.COM