

# Energy Recovery Ventilation System

Owner's Manual

Commercial Air Conditioners

Applicable Models (V Series):

CH-HRV3.5K

CH-HRV5K

CH-HRV8K

CH-HRV10K

CH-HRV15M

CH-HRV20M

Thank you for choosing commercial air conditioners.

Please read this Owner's Manual carefully before operation and retain it for future reference.

If you have lost the Owner's Manual, please contact the local agent or visit [www.cooperandhunter.com](http://www.cooperandhunter.com).

# Contents

1. Preface .....	1
2. Introduction to Product .....	1
2.1 Main Features .....	1
2.2 Features of Structure.....	2
3. Control.....	3
3.1 Operation Instructions .....	3
4. Outline Dimensions .....	8
5. Installation Instructions.....	9
5.1 General.....	9
5.2 Engineering Design .....	9
5.3 Installation Diagram.....	11
6. On-site Construction.....	12
6.1 Installation of the Controller.....	12
6.2 Fabrication of the Duct .....	12
7. On-site Construction Requirements .....	14
8. Electric Wiring.....	15
8.1 Wiring Installation .....	16
8.2 Grounding.....	16
8.3 Trial Run and Routine Maintenance .....	17
8.4 Troubleshooting .....	18
9. Safety Precautions .....	18
10. Technical Datasheet .....	20

## 1. Preface

This product complies with the national standard GB/T 21087-2007.

Modern civilization has brought more and more adverse effects to our living environment. With more and more wider application of the air conditioning and kinds of synthetic building materials, popularization of modern office equipment, enhancement of air tightness of the building, reduction of fresh air volume for energy saving and cost cutting, harmful gases and biologic pollutants inside the building cannot be diluted or discharged properly. Recently, healthy, energy-saving, simple and reliable fresh air system and equipment have become the focus for the HVAC engineers and users. Cooper&Hunter is a perfect solution for problems stated above for its dual-direction ventilation, that is, it can bring fresh air inside and meanwhile discharge polluted air outside. During ventilation, the high-efficiency heat-recovery equipment can keep the indoor temperature unchangeable. Besides, the equipped air filter can effectively filter air going inside. In short, new technologies and new materials make this new product of low energy consumption, excellent performance, low noise and simple installation etc.

## 2. Introduction to Product

### 2.1 Main Features

#### (1) Dual-ventilation

It can bring fresh air inside and deliver polluted air outside, which makes the users always feel natural comfort.

#### (2) Energy Recovery

During ventilation, imported air and exported air will make heat exchanger, and 70% of heat will be recovered.

#### (3) Low Noise

The specialized low-noise fan is used.

#### (4) Air Filtering

The internal air filter can guarantee the imported air clean and dustless.

#### (5) Large lineup

The large lineup can satisfy various

## 2.2 Features of Structure

ERV mainly consists of the main unit and the control.

### ◆ Main Unit

The main unit mainly consists of the centrifugal fan and the heat exchanger. Air before going inside the heat exchanger will pass through the filter, where dust particles and fibers will be sorted out. The internal air filter can be taken out from the access door. At the joint between the outer casing and the access door, there is long-lasting sealing material, which can make the whole cabinet airtight. The hot galvanized steel outer casing and insulation sponge attached to the external surface can absorb noise produced by the fan and also prevent dewing in summer.

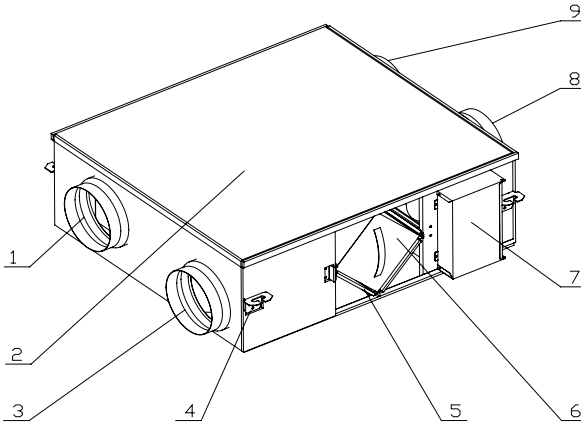

1.Polluted air outlet 2.Outer casing 3.Fresh air inlet 4.Lug 5.Air filter  
6.Heat exchanger 7.Electric box 8.Fresh air inlet 9.Polluted air inlet

Figure 1 Main Structure of CH-HRV Series

### 3. Control

#### 3.1 Operation Instructions

Caution!

- ◆ Do not install the control at the humid area.
- ◆ Do not beat, toss or frequently turn on/off this control.

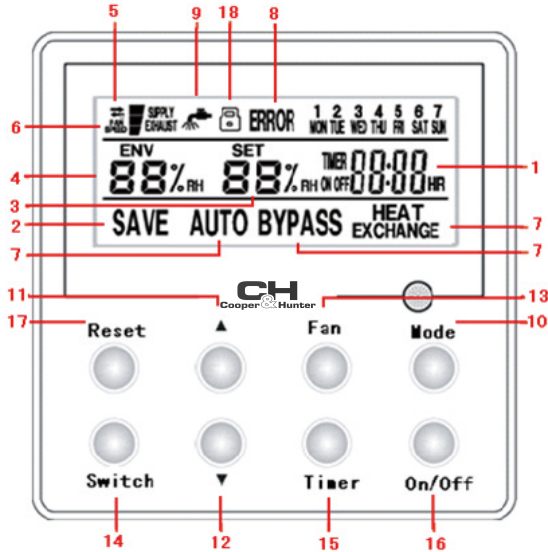

Figure 2 Front Panel of the Control

1	Timing set point	10	Mode key
2	Energy saving status	11	Humidity increasing key
3	Humidity set point	12	Humidity decreasing key
4	Environment temperature	13	Fan speed key
5	Air mode status (fresh air, discharge air, supply air)	14	Switching key
6	Fan speed status (hi/medium/low)	15	Timing key
7	Mode status (Auto, Bypass, Heat exchange)	16	On/Off key
8	Error status	17	Reset key
9	Filter cleaning status	18	Child lock icon

Note: for CH-HRV15 and CH-HRV20, there is no discharge air and supply air modes for the item number 5 and fan speed is uncontrolled for the item number 6.

## 3.1.1 On/Off



Figure 3

- ◆ By pressing the On/Off key, it is able to start/stop the control.
- ◆ Under the “Off” status, pressing the “Mode” key for 5 seconds can activate the memory function upon power failure. In this case, when 01 is displayed at the temperature set point area, it indicates the memory function has been activated. When 02 is displayed, the memory function has been deactivated. Then, by pressing the ‘On/Off’ key, this setting can exit. At the setting page, if there is not any operation during 20 seconds, the control will back to the normal “Off” status. The memory function is defaulted to be deactivated.

## 3.1.2 Control to the Fan Speed

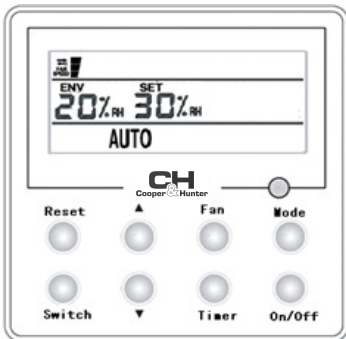

Figure 4

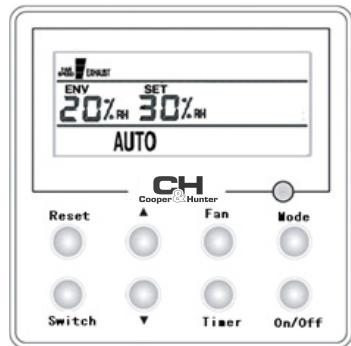

Figure 5

- ◆ As shown in the figure 4, under the fresh air mode, by pressing the “Fan” key, the fan speed will change circularly from low speed to medium speed to high speed, which however is unavailable for CH-HRV15 and CH-HRV20.
- ◆ As shown in the figure 5, under discharge or supply air modes, by pressing the “Fan” key, the fan speed will switch between low and high speed, which is also unavailable for CH-HRV15 and CH-HRV20.

## 3.1.3 Control to Humidity

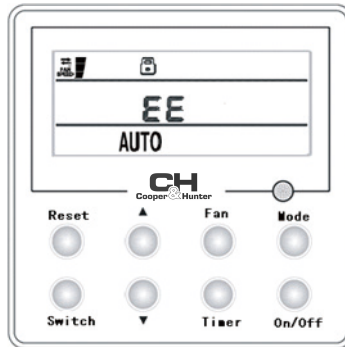

Figure 6

- ◆ For the unit with humidifying function, pressing the “▲” key will increase the humidity set point; while pressing the “▼” key will decrease the humidity set point. Each press will make the set point change by 5%.
- ◆ When pressing the “▲” and “▼” keys at the same time for five seconds, “EE” and a lock icon will be displayed. In this case, all key operation will be deactivated. Then, by pressing the “▲” and “▼” keys at the same time for five seconds again, the lock function will be deactivated.
- ◆ When the control is deactivated by remote monitoring or central control, “CC” will be displayed and all key operation and remote signals are invalid.
- ◆ The humidity range is 30%-70% (RH).

## 3.1.4 Switch/Reset

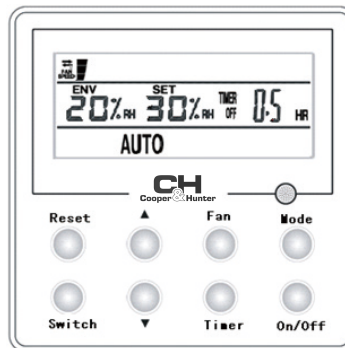

Figure 7

- ◆ When it is required to clean the unit, the beeper will raise an alarm for 30s. In this case, by pressing the “Reset” key for five seconds, the runtime for cleaning will become zero, the beeper will stop and the cleaning symbol will disappear.
- ◆ When the unit is turned on, by pressing the “Timer” key and then quickly pressing the “Switch” key, it will switch to timer for stopping the unit, timer for activating energy saving, timer for deactivating energy saving, and timer for cleaning circularly.

## 3.1.5 Run Mode

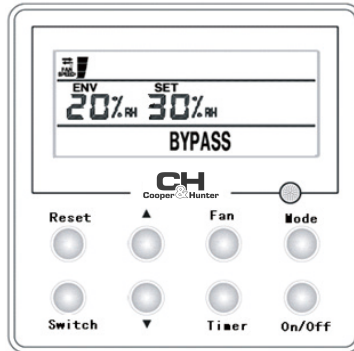

Figure 8

- ◆ By pressing the “Mode” key, the run mode will change circularly from automatic to bypass to heat exchange.
- ◆ Under the automatic mode, “AUTO” will light on and the system will operate based on indoor and outdoor temperatures as well as the temperature difference.
- ◆ Under the bypass mode, “BYPASS” will light on. When the damper is opened, the fan will work based on the air mode and fan speed settings. This mode is generally applicable to transitional seasons and will extend the service life of the heat exchanging core.
- ◆ Under the heat exchange mode, “HEAT EXCHANGE” will light on. When the damper is closed, the fan will work based on the air mode and fan speed settings. In this mode, it can realize all heat exchange for fresh air, saving more energy and being much healthier.

## 3.1.6 Timer

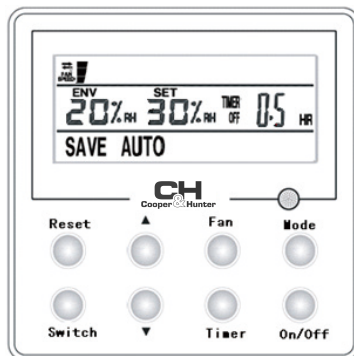

Figure 9

- ◆ When the unit is off, by pressing the “Timer” key, the unit can be timed on. When the unit is on, by pressing the “Timer” key, the unit can be timed off and energy saving function and cleaning function can be timed on separately. Under the setting status, “TIMER”, “HR” and the setting value will blink. At this point, by pressing the “▲” / “▼” key, the setting value will increase or decrease by 0.5 hours at a time. Then, by pressing the “Timer” key, this setting will become valid. When the timer works, by pressing the “Timer” key again, it will be



canceled.

- ◆ The setting rang for timing the unit on/off is 0.5~24 hours.
- ◆ The setting range for timing the energy saving function on is 2~5 hours. The default setting is 2 hours.
- ◆ The setting range for timing the energy saving function off is 1~4 hours. The default setting is 1 hour. Only when this timing expires, energy saving function can be timed on by pressing “Fan” and “▼” at the same time for five seconds.
- ◆ The setting range for timing the cleaning function on/off is 1250 hours, 2500 hours and a variable to be determined. The default setting is 1250 hours.
- ◆ Only when the timer works, the setting value will decrease with time.

### 3.1.7 Environment Humidity

- ◆ Generally, it indicates the indoor environment humidity.

Note: for the unit with humidifying function, the humidity will be displayed only when this function is activated.

### 3.1.8 Humidifying On/Off

- ◆ By pressing the “Mode” and “▼” key at the same time for five seconds, the humidifying function will be switched to be on or off alternatively.
- ◆ For the unit with the humidifying function, only it has been activated, both the indoor humidity and humidity set point will be displayed. This function is defaulted to be off. In the dry seasons, it is suggested to activate this function.

### 3.1.9 Air Mode

- ◆ By pressing the “Mode” and “▲” keys at the same time for five seconds, fresh air mode, discharge air mode and supply air mode can be switched circularly. See figure 2 for more details. The air mode is decided by the user. When positive pressure is required indoor, supply air mode is satisfactory. When negative pressure is required, discharge air mode is favorable. In generally, fresh air mode is satisfactory.

### 3.1.10 Energy Saving

- ◆ By pressing the “Fan” and “▲” keys at the same time for five seconds, the energy saving function can be switched on or off alternatively. When this function has been activated, “SAVE” will be displayed. When the unit is not required to run for long time, this function can not only provide fresh air but also guarantee the indoor air quality.

### 3.1.11 Error Display

- ◆ When some error occurs, “ERROR” and error codes will be displayed.

Error Codes	Error Description
E6	Communication error
F0	Indoor temperature sensor error
L1	Humidity sensor error
F3	Outdoor temperature error
L0	Damper error

### 3.1.12 Intelligent Start/Stop

- ◆ It is also called the central control for dampers, which are used for multiple rooms but are under the control the one unit. It can totally control eight dampers. A patching board is required.

### 3.1.13 Address Setting

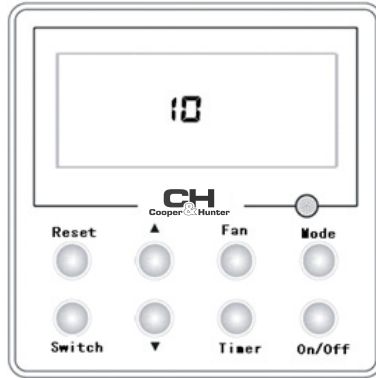

Figure 9

- ◆ When the unit is off, by pressing the “Mode” and “▲” keys at the same time for five seconds, it is able to set the address of the control (1~16). At this point, address can be increased or decreased by pressing the “▲” or “▼” key. This address intends to distinguish different dampers. The default address is 16. By pressing the “On/Off” key, this setting will exit. When there is no any key operation in 20 seconds, this setting ends and becomes valid.

## 4. Outline Dimensions

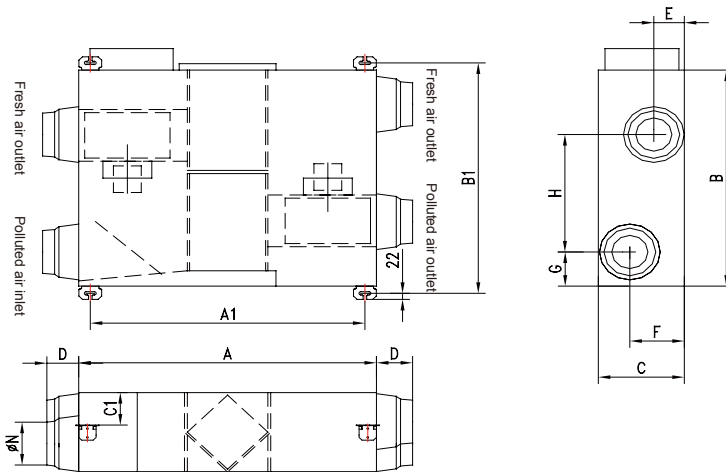

Figure 10 Outline Dimensions\

Model	A	A1	B	B1	C	C1	D	E	F	G	H	N
CH-HRV3.5	879	823	800	852	306	125	90	125	175	136	416	197
CH-HRV5	879	823	800	852	306	125	90	125	175	136	416	197
CH-HRV8	1016	960	832	884	380	165	90	150	230	155	372	246
CH-HRV10	1016	960	832	884	380	165	90	150	230	155	372	246
CH-HRV15	1215	1159	1210	1262	452	200	100	190	277	178	737	297
CH-HRV20	1215	1159	1210	1262	452	200	100	190	277	178	737	297

## 5. Installation Instructions

### 5.1 General

The user should entrust HVAC engineers for equipment selection and design and invite the qualified construction organization for on-site construction. Both design and construction should comply with corresponding national regulations and codes. When the unit fails to operate normally owing to improper installation, service charge will be required.

### 5.2 Engineering Design

Two passages of ducts for ventilation are required for the dual-direction ventilation. One is used to discharge polluted air inside out, and the other is used to bring fresh air inside. When passing through the duct, certain resistance will be produced. The larger the resistance it, the smaller the air flow is. Besides, length and size of the pipe, quantity of the bends also would affect the air flow. Therefore, do the design as stated below:

- (1) Generally each passage for ventilation does not exceed 15~30m. Internal sectional area depends on inner air flow. Air flow for the main pipe is about 8m/s and for the branch is 5m/s.
- (2) When the rectangular duct is used, proportion of two neighboring sides cannot exceed 4. The duct should be made of non-inflammable materials.
- (3) The bends should be kept as few as possible and do not exceed 3 for each passage. The curving part of the bends should be round-arc, and the straight angle should be avoided, as shown in the figure below.

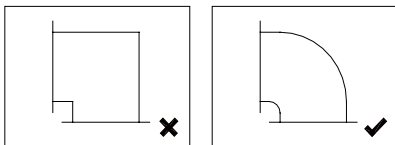

Figure 11 Bend Type

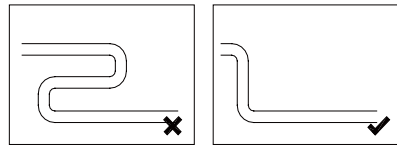

Figure 12 Pipe Arrangement

- (4) The duct wall should be smooth, dustless and pucker-free.
- (5) Resistance to the air opening should be kept as less as possible. It is suggested to install no less than 200×200mm rectangular aluminum alloy diffusers or dual-layer grilles. If it is the water-proof grille, its size should be 3~4 times that of the sectional area of the connected duct and blade shape of the grille should facilitate passing of air flow. See figure 13 for how to select diffusers and grilles.

- (6) In order to prevent discharged air returning back, distance of two air openings at the wall should be kept larger than 1000mm, as shown in the figure 14.

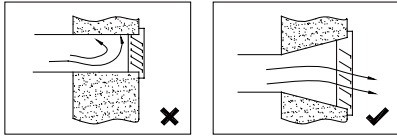

Figure 13 Shape of the Air Opening

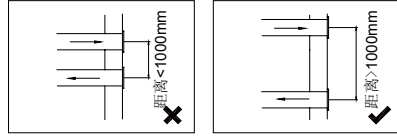

Figure 14 Distance between Air Openings

- (7) When it is expected to minimize indoor noise, it is suggested to install a muffler inside the pipe. Please contact a specialist for how to select the muffler. Generally, the muffler can make noise reduced by 4~6dB.
- (8) When an electric heater is installed, it should be interlocked with the ventilator. That is, the electric heater will work only when the ventilator has been started. Ducts within a distance of 800mm with the electric heater and ducts which go through a room where there is a fire source, they should be made of non-inflammable materials.
- (9) The filtering element should be replaced periodically. Therefore, a certain distance should be kept at one side for maintenance.
- (10) A steel hanger frame should be pre-buried before installation. Type and size of the hanger frame depends on weight of this product. For the retrofitting project, drill holes at the ceiling for the hanger frame, as shown in the figure 15(a). When hole drilling is unavailable, locate the reinforcing steel inside concrete and take it as the hanger frame, as shown in figure 15(b).

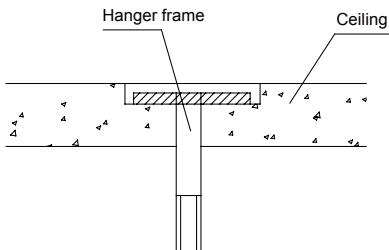

Figure 15 (a)

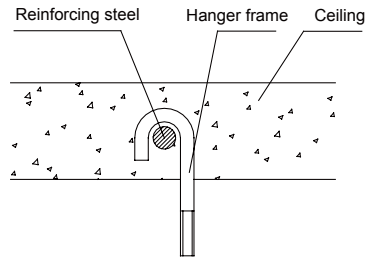
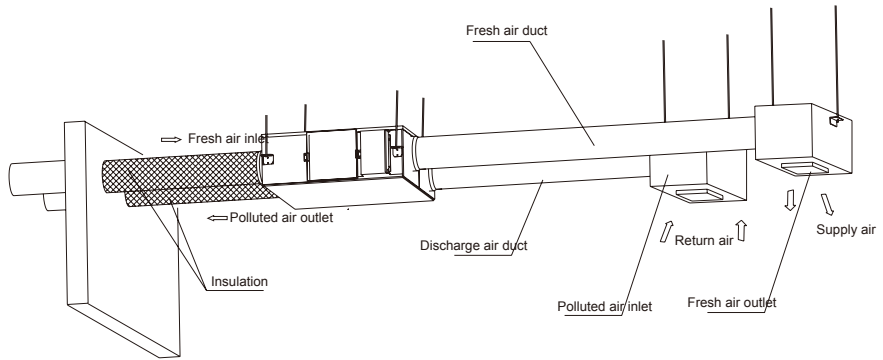

Figure 15 (b)

When the ceiling is damaged during installation of the hanger frame, it should be repaired before completion of this project.

### 5.3 Installation Diagram



Note: outdoor ducts connected with the fresh air inlet and polluted air outlet should be insulated, so do indoor ducts when temperature and humidity is quite high inside the ceiling. Besides, the indoor ducts should keep a certain gradient (1/50~1/30) to prevent water entering inside.

For convenient cleaning to maintenance to the internal filter and heat exchanger, please keep a certain inspection and maintenance space. See figure 17 for the access hole.

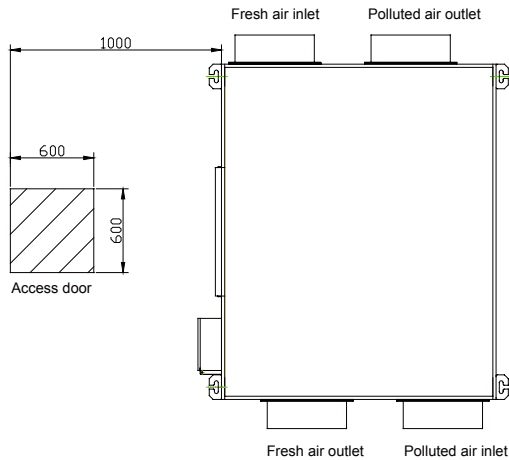

Figure 16 Installation Diagram of CH-HRV Series

## 6. On-site Construction

### 6.1 Installation of the Controller

(1) Firstly, locate the installation place and make a slot or hole for the communication lines.

(2) When the control and the indoor unit are installed on the wall surface, use 1# PVC pipe and the slot as shown in the figure 18. When they are concealed installed, only 1# PVC pipe is required, as shown in the figure 19.

(3) After that, as shown in figure 20, drill two holes as per installation holes at the base plate of the control, insert a wooden cork inside the hole, fix the control on the wall through these two holes, connect the communication line and put the front panel on.

Note: during installation, pay attention to the direction of the base plate. The side with two notches should be downwards; otherwise the installation of the front panel would fail.

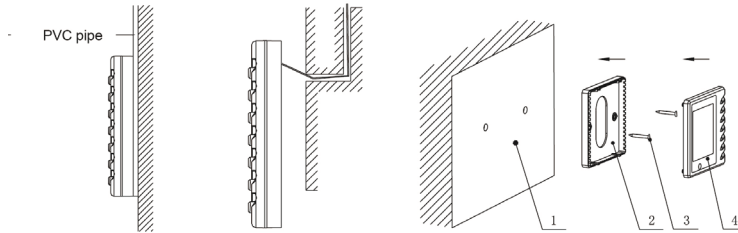

Figure 18

Figure 19

Figure 20

No	Description	Remarks
1	Wall	Installation figures shown above are just for reference.
2	Base plate	
3	Screws M4X25	
4	Front panel	
5	Screws ST2.2X6.5	

Note: the communication distance between the main board and the control can be up to 20m (the standard is 8m).

### 6.2 Fabrication of the Duct

(1) All sheet and sectional materials should be with certificate of qualification.

(2) Thickness of the steel should comply with requirements on the drawing.

(3) There should be no crack, scar and watermark on the galvanized steel but crystal pattern.

(4) Size of the duct should comply with design requirements.

(5) Joint of the duct should be airtight, even, crack etc.

(6) For the duct, angle should be straight, round arcs should be even and unevenness should be within 5mm.

(7) Connection between the duct and the flange should be fastened and flanging width should be no less than 6mm. Holes spacing of flanges should meet design requirements and construction regulations

(8) Surface of the carbon steel flange should be applied with red anti-rust paint and coating

should be even and closely-packed.

(9) See the table below for allowable deviation for the duct and flange.

Allowable Deviation for the Duct and Flange

No	Item	Allowable Deviation (mm)	Inspection Method
1	OD of the round duct	$\varphi \leq 300\text{mm}$	0
		$\varphi > 300\text{mm}$	-1
2	Long side of the rectangular duct	$\leq 300\text{mm}$	0
		$> 300\text{mm}$	-1
3	Diameter of the round flange	0	Measurement by the ruler
4	Longer side of the rectangular duct	+2	
5	Differential of diagonals	3	Measurement by the ruler
6	Evenness	2	Measurement by the feeler
7	Smoothness of welding joints	1	

Notes:

The absolute value of differentials of diagonals of the rectangular duct should be  $|L1 - L2| \leq 3$ , as shown in figure 21.

For flanges at two ends of the bend of the rectangular duct, the squareness tolerance should be 3.0 (90°), as shown in figure 22.

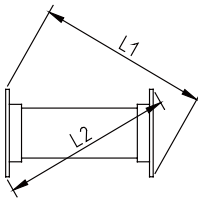

Figure 21

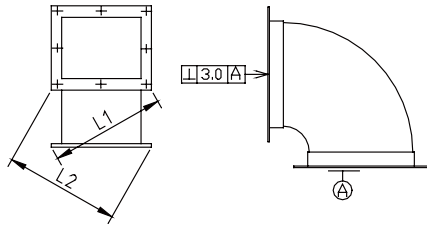

Figure 21

## 7. On-site Construction Requirements

- (1) Never lay wires, cables and pipes with toxic, inflammable or explosive gas or liquid in the duct.
- (2) The dismantable ports and adjustable parts of duct and fittings cannot be installed in the wall or ceiling.
- (3) Foreign matters in or on the duct and fittings should be cleaned before installation.
- (4) The construction of bracket or hanger of the duct should accord with the following specifications:
  - ① The build-in fitting, setting nail or expansion bolt for bracket or hanger should be placed correctly and firmly .The inlet part should be free of oil stains and painting.
  - ② The layout of the bracket or hanger should accord with design specifications. If there is no design specification, following specifications will apply.
    - a. Pole bracket or inclined bracket is applicable for horizontal duct against wall or pole and support bracket for that far from wall or pole. Strip hanger is applicable for the duct with diameter or length of side less than 400mm.
    - b. Arm bracket or inclined bracket is applicable for vertical duct against wall or pole and anchor ear bracket for that far from wall or pole .The vertical pipe outside the room or on the roof should be fixed with derrick or dragline.
  - ③ The hanger's rod should be flat and its screw thread should be intact and smooth. Either threaded connection or welding is suitable for joint of hangers. If the former one is adopted, connecting thread of either end should be longer than diameter of hanger; moreover, anti-loosening measure should be made. If the latter one is adopted, lapping joint is applicable and its length should be 6 times longer than diameter of hanger at least at two sides.
  - ④ Holes on the bracket and hanger should be drilled mechanically and never by gas cutting.
  - ⑤ For the rectangular duct, clamps for the rectangular should contact the duct tightly, angle should be straight, and space for the screw at the joint should be reserved. For the round duct, clamps should be arranged evenly and its inner diameter should be the same with the outer diameter of the duct so as to contact the duct tightly.
- (5) The bracket and hanger cannot be set at air vent, valve or service door. The hanger cannot be directly fixed at flange. The distance between horizontal duct bracket and hanger cannot exceed 4m.If the duct is installed vertically, the distance between them should not exceed 4m and the built-in fittings of each vertical duct should be more than 2 pieces.
- (6) The duct flange, hanger and hanger for equipment should be coated with anticorrosion paint.
- (7) The floor and wall which the duct passes should be repaired after construction. The holes on the external wall should be kept 2/100 gradient at level direction (the internal is higher) to avoid rainwater into the room.
- (8) Installation of duct and connection between the air vent and duct should be firm. The frame and decorative surface should be solid, external surface should be level and in-deformable and adjustment should be flexible.



## 8. Electric Wiring

The electric wiring attached to the electric box always prevails.

(1) CH-HRV3.5, CH-HRV5, CH-HRV8, CH-HRV10

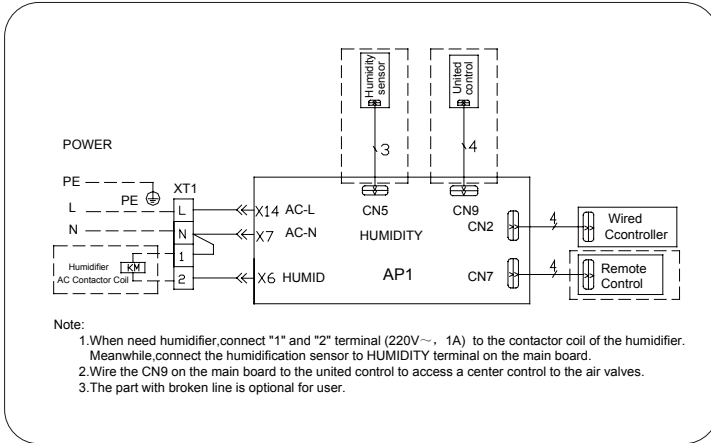

- ◆ When the humidifier is required, wire the wiring board terminal 2 (220V) to the humidifier AC contactor. Meanwhile, prepare and insert a humidity sensor into the corresponding terminal at the main board.
- ◆ Parts enclosed with broken lines should be prepared by the user.
- ◆ Power lines also should be prepared by the user.

(2) CH-HRV15, CH-HRV20

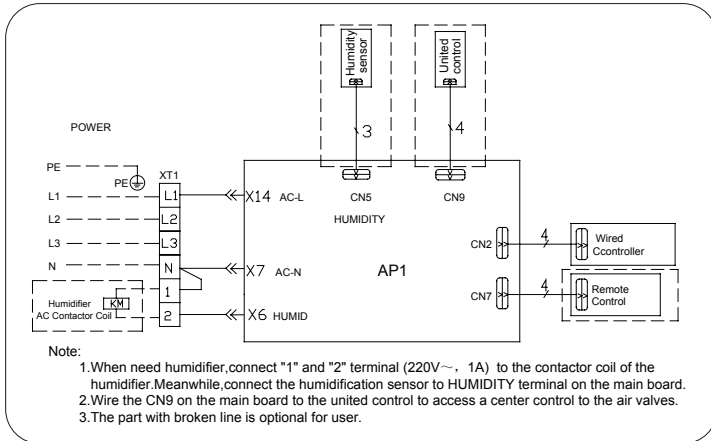

- ◆ When the humidifier is required, wire the wiring board terminal 2 (220V) to the humidifier AC contactor. Meanwhile, prepare and insert a humidity sensor into the corresponding terminal at the main board.
- ◆ Parts enclosed with broken lines should be prepared by the user.
- ◆ Power lines also should be prepared by the user.

## 8.1 Wiring Installation

### 8.1.1 Wiring Arrangement

- ◆ Layout of wires should accord with national wiring standards.
- ◆ The power supply must be under rated voltage and used especially for this product.
- ◆ The power supply should be reliable to prevent terminals from being stressed. Never pull the power cord forcibly.
- ◆ Size of the power lines must be large enough. The broken power line should be replaced with the dedicated line.
- ◆ All of the electric installation must be performed by qualified technicians according to local laws and regulations and instructions.
- ◆ The grounding wire should be reliably connected with special grounding device and performed by qualified technicians.
- ◆ Air switch and leakage switch which can cut off the general power supply should be installed.
- ◆ The air switch should integrate the functions of magnetic release and hot release to protect it for short circuit or overload.
- ◆ The field wiring should be subject to circuit diagram attached on the unit.

Applied models	Power supply	Capacity of air switch (A)	Min. sectional area of grounding wire (mm <sup>2</sup> )	Min. sectional area of power cord (mm <sup>2</sup> )
CH-HRV3.5K	220V~50Hz	6	1.0	1.0
CH-HRV5K	220V~50Hz	6	1.0	1.0
CH-HRV8K	220V~50Hz	6	1.0	1.0
CH-HRV10K	220V~50Hz	6	1.0	1.0
CH-HRV15M	380V 3N~50Hz	6	1.0	1.0
CH-HRV20M	380V 3N~50Hz	6	1.0	1.0

#### Notes:

- a. The power lines for this product must be copper cored cable, and working temperature cannot exceed the specified value.
- b. When the power lines exceeds 15m, please enlarge its sectional area to avoid incidents caused by overloading.

## 8.2 Grounding

- ◆ Reliable grounding measure must be adopted. The yellow green grounding can never be cut off and fixed with tapping screws so as to avoid electric shocks.
- ◆ The grounding resistance should comply with the local standard.
- ◆ Power supply must be reliably earthed. The grounding wire cannot connect with:
  - a. Tap water pipe;
  - b. Gas pipe;
  - c. Blowing tube;

d. Place which specialist considers unreliable.

Warning: Cut off the power supply before installation and maintenance to avoid electric shock. Wiring arrangement should comply with corresponding requirements, otherwise it would lead to electric shocks or fires etc.

Special Notice: C&H won't be responsible for adverse results caused by modification of the electric control system by the users themselves without consent of C&H.

### 8.3 Trial Run and Routine Maintenance

Check wirings and perform trial run after installation work.

- ◆ Check before Trial Run

- (1) Check of the pipeline system

According to design drawing and this manual check layout of ducts, firmness of hangers, anticorrosion paint and items stated above which should be paid attention to, operation space for replacement of the air filter, installation location of the duct silencer, inside or top of the duct or equipment, and firmness of installation.

- (2) Check of the electric circuit system

According to the circuit diagram, check for the incoming lines, connection method, connections and power voltage.

- ◆ Trial Run

- (3) Turn on the unit. Refer to Section 6.1 for more details.

- (4) When there is any unusual condition, cut off the power supply immediately for troubleshooting.

- ◆ Routine Maintenance

The air filter must be installed, if not, the heat exchanging core will be covered with feculence and dust so that its performance will be reduced. If airflow volume or discharge air volume is obviously decreased, the filter should be replaced. Replacement period can be displayed through the controller and can be changed according to actual conditions in each area. The replacement method is quite simple. That is, open the access door, take out the old filter, place the new one, and then close the access door.

Remember to cut off the power supply before installation and maintenance to avoid electric shock. Wiring arrangement should comply with corresponding requirements, otherwise it would lead to electric shocks or fires.



### 8.4 Troubleshooting

After trial run, the unit can be normally used by the user. If any fault occurs resolve it firstly by yourself according to the following table.

Symptoms	Possible causes	Solutions
Airflow volume at air outlet/inlet is obviously decreased after a period of time.	Too much dust gathers on the air filter.	Replace or clean the air filter.
Noise occurs at the air vent.	Installation of the air vent is loose.	Re-fix the air vent.
The system fails to be started.	<ul style="list-style-type: none"> <li>• Power failure or incorrect power lines</li> <li>• Loosened transformer terminals at the main board</li> <li>• Communication error</li> <li>• Damper or relative parts error</li> <li>• Unconnected damper control at the main board</li> </ul>	<ul style="list-style-type: none"> <li>• Recover power supply and check for wiring of the power supply.</li> <li>• Reconnect the transformer terminal.</li> <li>• Check for connection between the controller and the main board.</li> <li>• Check for the by-pass damper and the drive.</li> <li>• Connect it.</li> </ul>

### 9. Safety Precautions

- ◆ Before installation, please carefully read this section carefully.
- ◆ Be sure to comply with statement listed below to prevent damage or personal injury.
- ◆ Damage or personal injuries can be classified as below.

 Danger	This mark means that dangerous cases like death or serious harm will happen.
 Warning	This mark means that dangerous cases like death or serious harm may happen.
 Notice	This mark means that injury or damage to property may happen.

 **Warning**

- Installation should be done by qualified technicians. Never install, move or retrofit the unit by yourself. Improper installation would cause the unit falling off, electric shocks, fires etc.
- This product should be installed strictly in accordance with this manual.
- Electric wiring should be performed as per national standards and regulations.
- Poor capacity and improper wiring of power lines would cause electric shocks, fires etc.
- A protective net is required at the air vent. When there is a bird nest, clean it, otherwise it would lead to oxygen deficit.
- The outdoor air inlet/outlet should be kept far away from the vent where inflammable gas will be discharged; otherwise it would lead to oxygen deficit.
- The air inlet should be where air would not go back; otherwise it would make the indoor air polluted.
- The unit should be installed where it is strong enough to withstand the unit.
- The grounding wire cannot be connected with the water pipe, lightning rod, phone line etc. Improper grounding would lead to electric shocks.
- Do cut off the power supply though the main break before maintenance, otherwise it would lead to electric shocks.
- Never insert the finger or stick into the air inlet or outlet, as it would lead to personal injury when the fan runs at high speed.
- Ventilate the room by opening the windows if inflammable gas leaks, otherwise spark produced by the contactor would lead to explosion or fire.
- Keep the unit operating under the rate voltage, otherwise it would lead to electric shocks or fires.
- When any unusual conditions occurs, stop the unit and cut off the power supply, otherwise it would lead to electric shocks or fires.
- Never let animals or plants at the air vent, as they would suffer adverse effects.
- For metal pipes which would go through metal structures of the building, it should be insulated, otherwise it would lead to electric shocks or leaks.

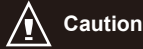
**Caution**

- Do not put the burner where would be affected by the main air vent, as it would lead to inadequate burning.
- The top surface of the unit should be water-proof, as water leak would lead to electric shocks.
- Do not use inflammable gas near this unit, as it would lead to fires.
- Operate the switch correctly and never repeat frequently.
- Do not wash the unit with water, as it would lead to electric shocks.
- Do not operate the with wet hands, as it would lead to electric shocks.
- Clean the filter periodically, as heavy dust would lead to indoor oxygen deficit.
- Wear gloves when cleaning the filter and heat exchanger, as it would lead to injuries.
- When the unit is not to be used for long time, please cut off the power supply.
- Do not install the unit in the bathroom and other places with high relative humidity, otherwise it would lead to electric shocks.
- Do not install the unit where there is a fire source or open fire, otherwise it would lead to overheating or fires.
- Do not install the unit where inflammable gas would leak, as it would lead to fire hazards.
- Do not install the unit in the chemical factories which produces acids, alkalis, organic solvents, coatings and other harmful and corrosive gases, otherwise it would lead to toxication or fire hazards.
- The access hole should be reserved for cleaning and servicing the filter and heat exchanger.

**Danger**

This product cannot be used for air exchange of the burner. When a gas heater is used in the room, special ventilation equipment must be used.

## 10. Technical Datasheet

Model	Rated Fresh Air Volume (m <sup>3</sup> /h)	External Static Pressure (Pa)	Heat Recovery Efficiency %	Noise Db(A)	Rated Power (W)	Power Supply
CH-HRV3.5	350	100	71	37	165	220V, 50Hz
CH-HRV5	500	100	68	39	262	
CH-HRV8	800	110	70	45	400	
CH-HRV10	1000	110	75	46	440	
CH-HRV15	1500	150	73	48	800	380V 3Ph, 50Hz
CH-HRV20	2000	150	71	50	950	

**COOPERANDHUNTER INTERNATIONAL CORPORATION**

[www.cooperandhunter.com](http://www.cooperandhunter.com)



600005000081